



SPECIALS
of the
MONTH

Mothers Day Feast * P124 MEALS IN HONOR OF Mom	FOOD LOVER'S TOUR of Charleston P136
30 MIN. MEALS * P108	OUTDOOR Baseball * P118
SAMMIES * PASTA-BREAKFAST * P130	AMERICAS LUNCHEON PARTY

Accordion system is dedicated to **multiple leaves folding doors**, combinable with pivot joints or hinges.

The system allows a configuration of **three or four leaves**.

The **sliding system is fixed in centrally to each leaf**, in order to grant an always balanced motion.







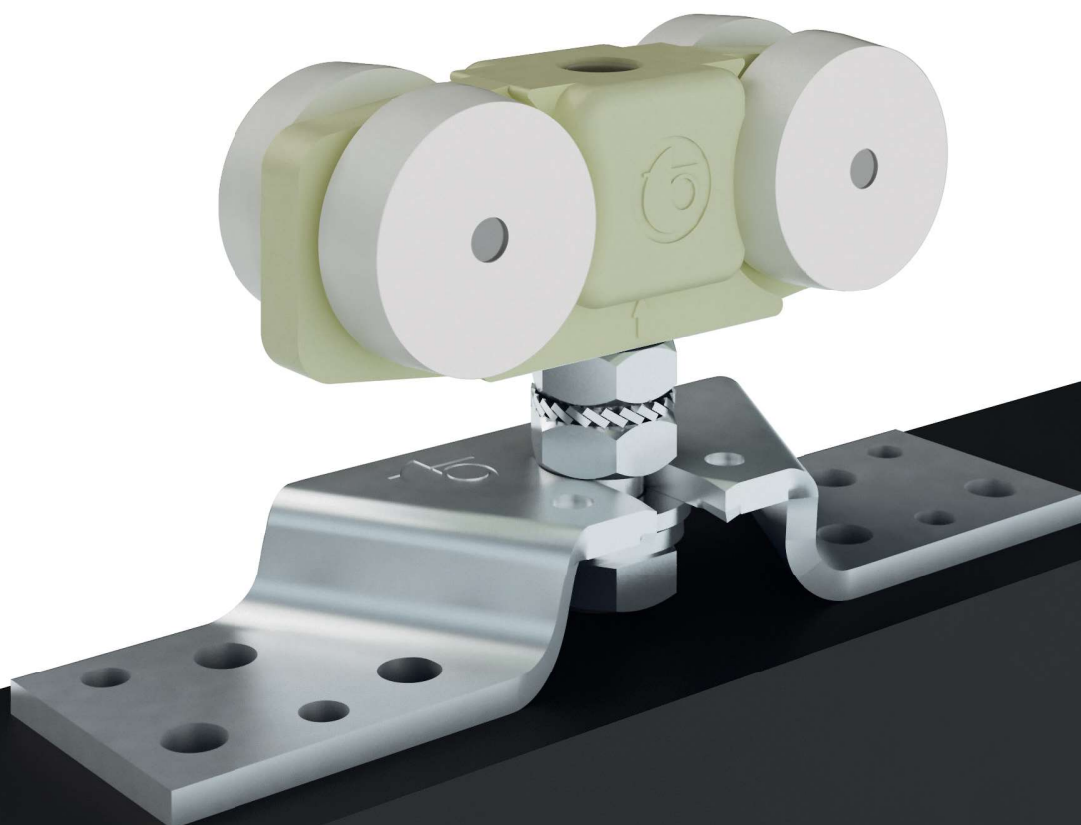

Accordion è il sistema per **porte a fisarmonica pieghevoli** ad ante multiple, utilizzabile con cardini o cerniere.

Il sistema permette una **configurazione a tre o a quattro porte**.

Lo **scorrevole** viene **fissato centralmente**, per il corretto bilanciamento delle ante.



Accordion COMPLETE BOX KIT / KIT COMPLETO IN SCATOLA 

K	Complete kit / Kit completo		
	.		
	0223		N° 4 Doors N° 4 Porte
	0224		N° 3 Doors N° 3 Porte
		.	
			1  With hinges - ART. 1138 Con cardini - ART. 1138
			2  With hinges - ART. 1148 Con cardini - ART. 1148
			3  With hinges - ART. 1751 Con cerniere - ART. 1751
			4  With hinges - ART. 1753 Con cerniere - ART. 1753
			5  With hinges - ART. 1755 Con cerniere - ART. 1755
			6  With hinges - ART. 1757 Con cerniere - ART. 1757

EXAMPLE / ESEMPIO

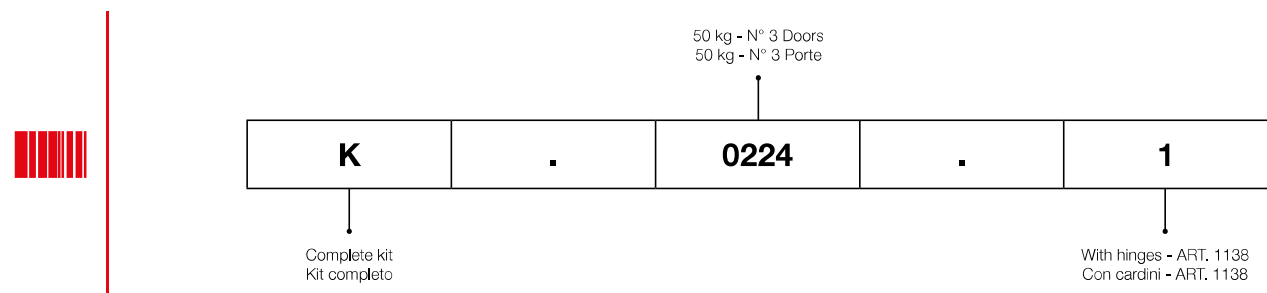

Tracks / Binari ALUMINUM FINISHES CODES / CODICI FINITURE ALLUMINIO 

CODE / CODICE	FINISH COLOR / COLORE FINITURA	
8 00 0.0	 00 G	Raw - Mill Finish / Neutro - Grezzo
8 01 0.0	 01 A	Anodized Silver / Argento
		STANDARD

Accordion

Accordion door
Porta pieghevole a fisarmonica

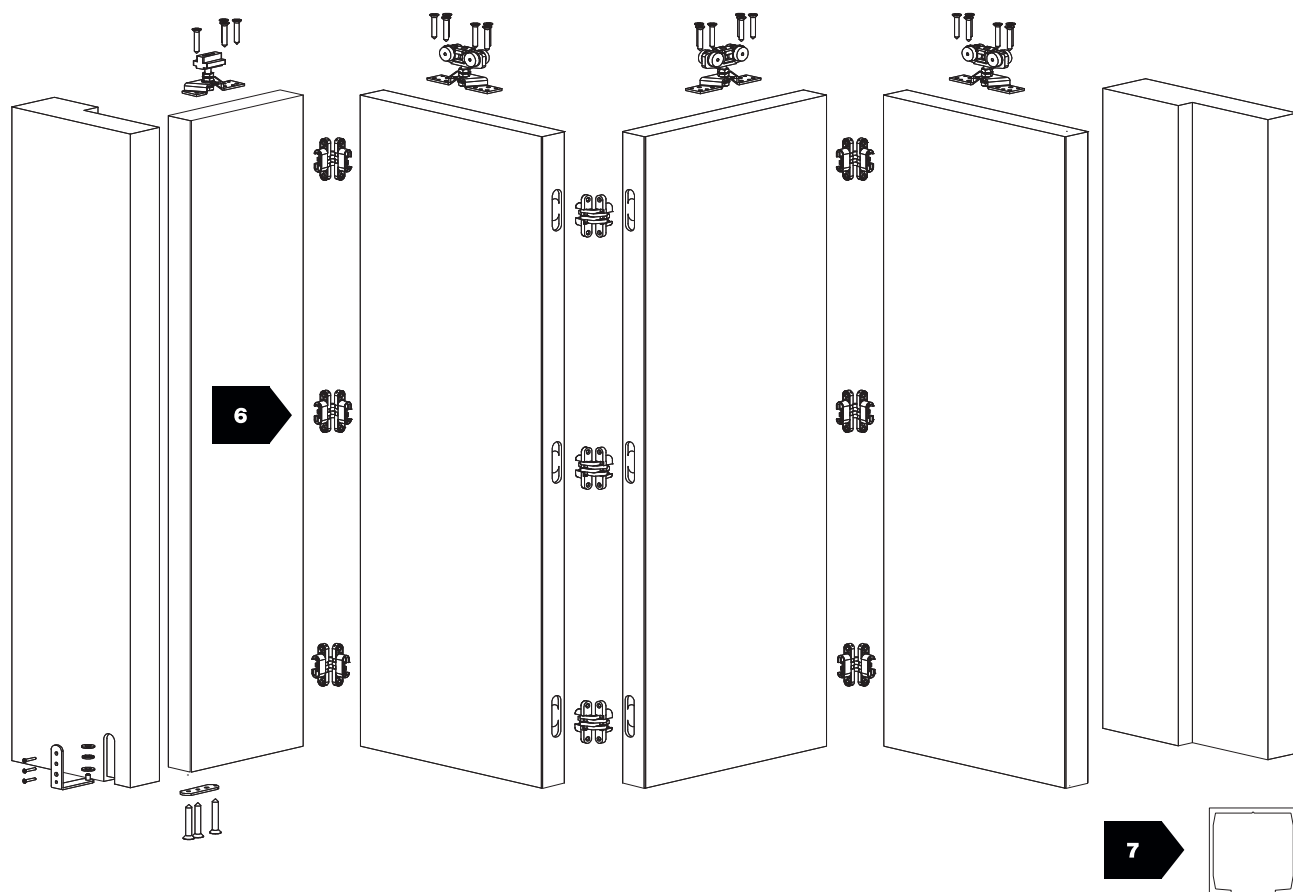
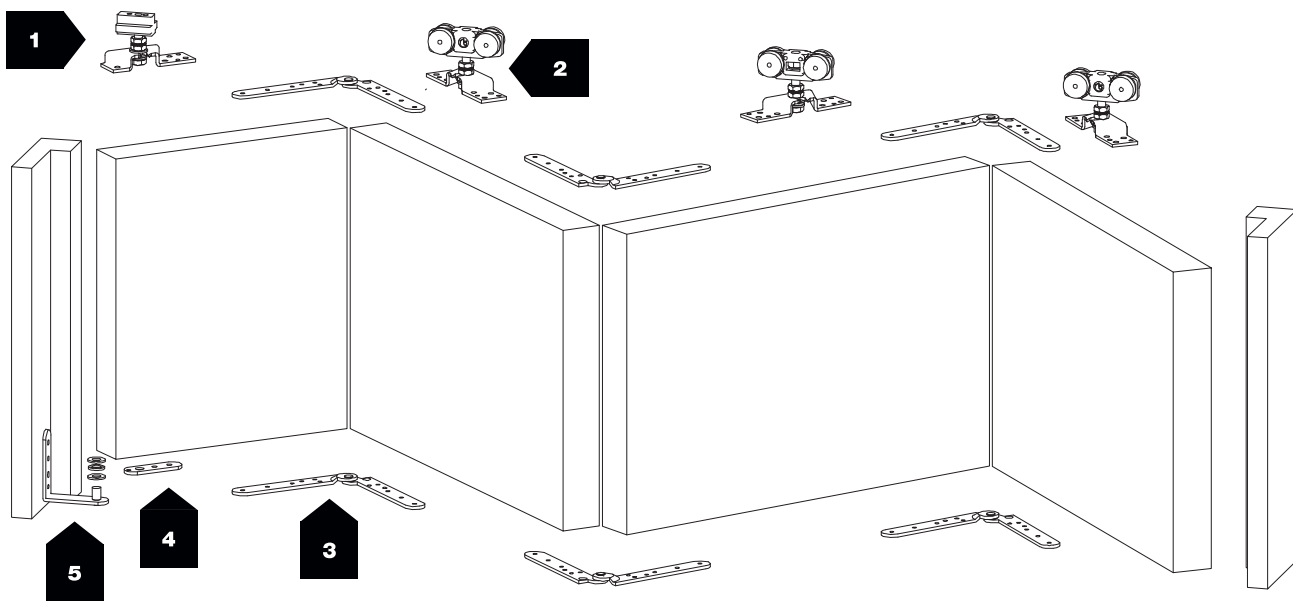



Min. 30 mm



40 kg

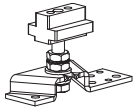
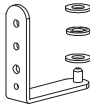
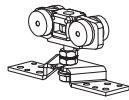
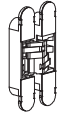
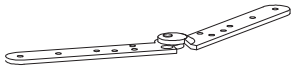
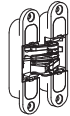
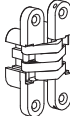
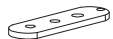

5 mm

N°	Barcode		KG		N°	Barcode		KG	
1	1188		40		5	1187		40	
2	1189		40		6	1751/N		40	
3	1138		40			1753/N		40	
	1148		40			1755/N		40	
4	1186		40			1757/PI		40	
						7	1080 8 00 0.01080 8 01 0.01080		40

Accordion

Accordion door
Porta pieghevole a fisarmonica



40 kg
(each door / per porta)



3 doors
3 porte



With hinges
Con cardini

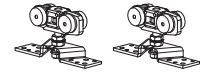
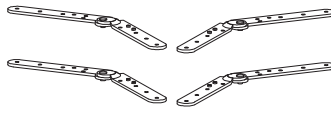
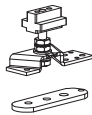
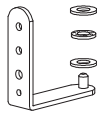

OLD CODE	NEW CODE		
1188/1138/3P	K.0224.1	Close up doors / Ante ravvicinate	4x
1188/1148/3P	K.0224.2	Spaced doors / Ante distanziate	4x



40 kg
(each door / per porta)



4 doors
4 porte



With hinges
Con cardini

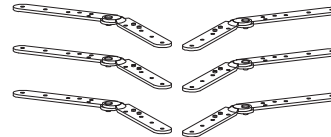
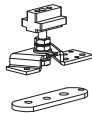
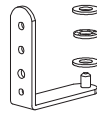

OLD CODE	NEW CODE		
1188/1138/4P	K.0223.1	Close up doors / Ante ravvicinate	4x
1188/1148/4P	K.0223.2	Spaced doors / Ante distanziate	4x

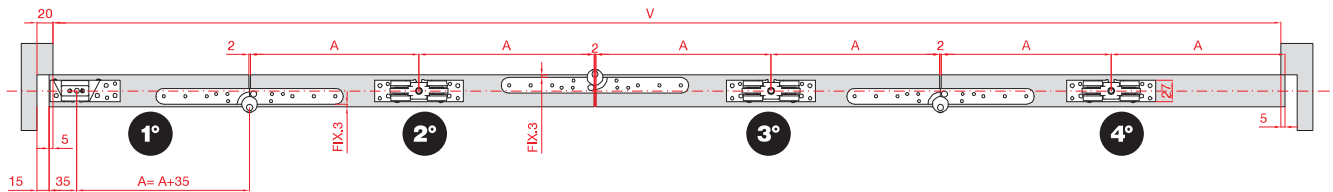

DRILLING / FORATURA



ART.1080

8 00 0.01080

8 01 0.01080

3 DOORS / PORTE - 50 kg (EACH DOOR / PER PORTA)
A=V+5+5-2-2-35:5



4 DOORS / PORTE - 50 kg (EACH DOOR / PER PORTA)
A= V+5+5-2-2-35:7

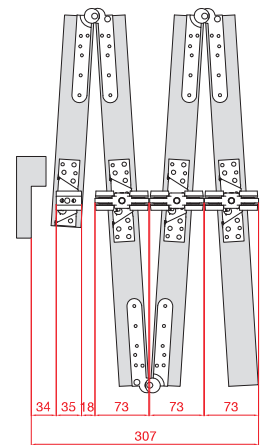
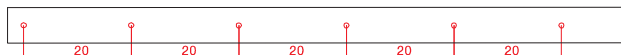

COMPOSITION FOR ACCORDION DOORS / COMPOSIZIONI PER PORTE A FISARMONICA

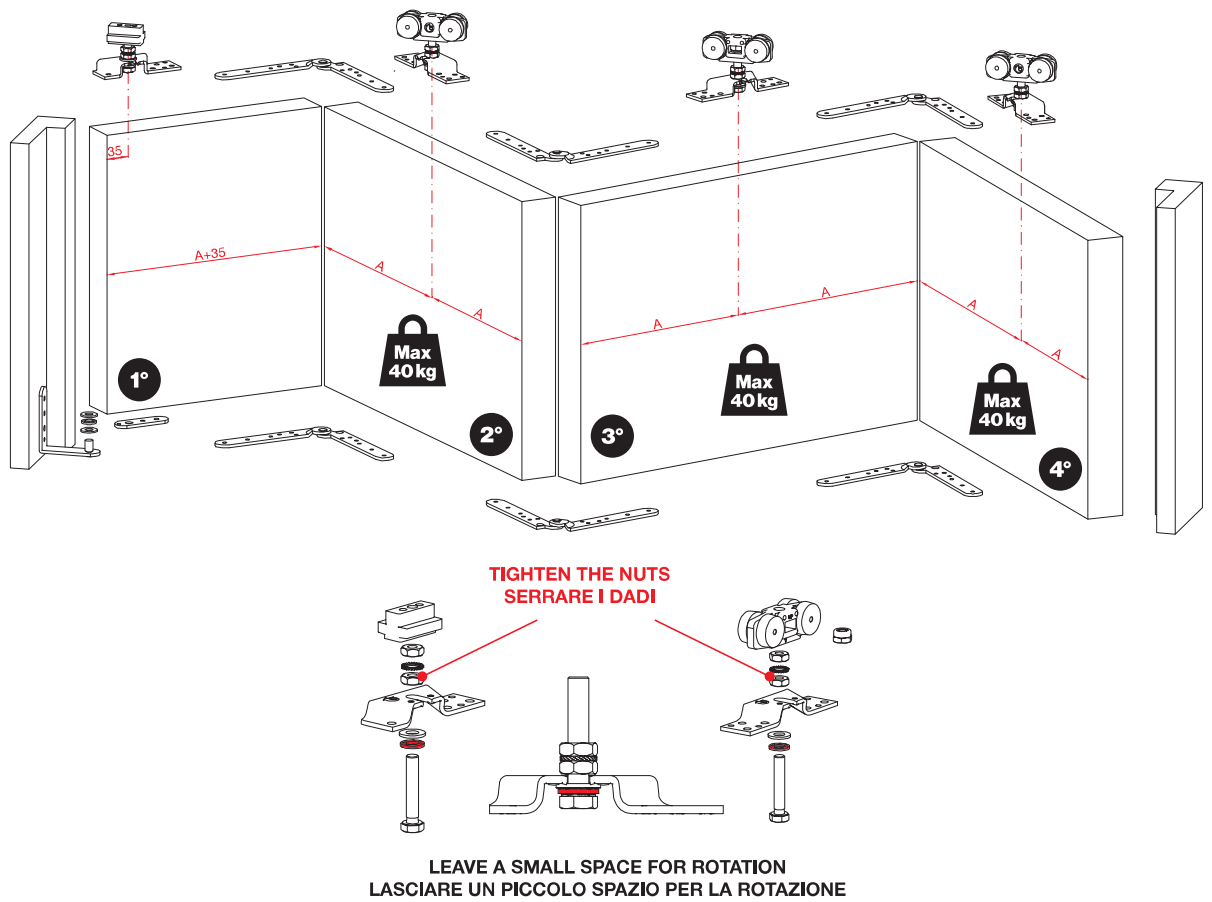
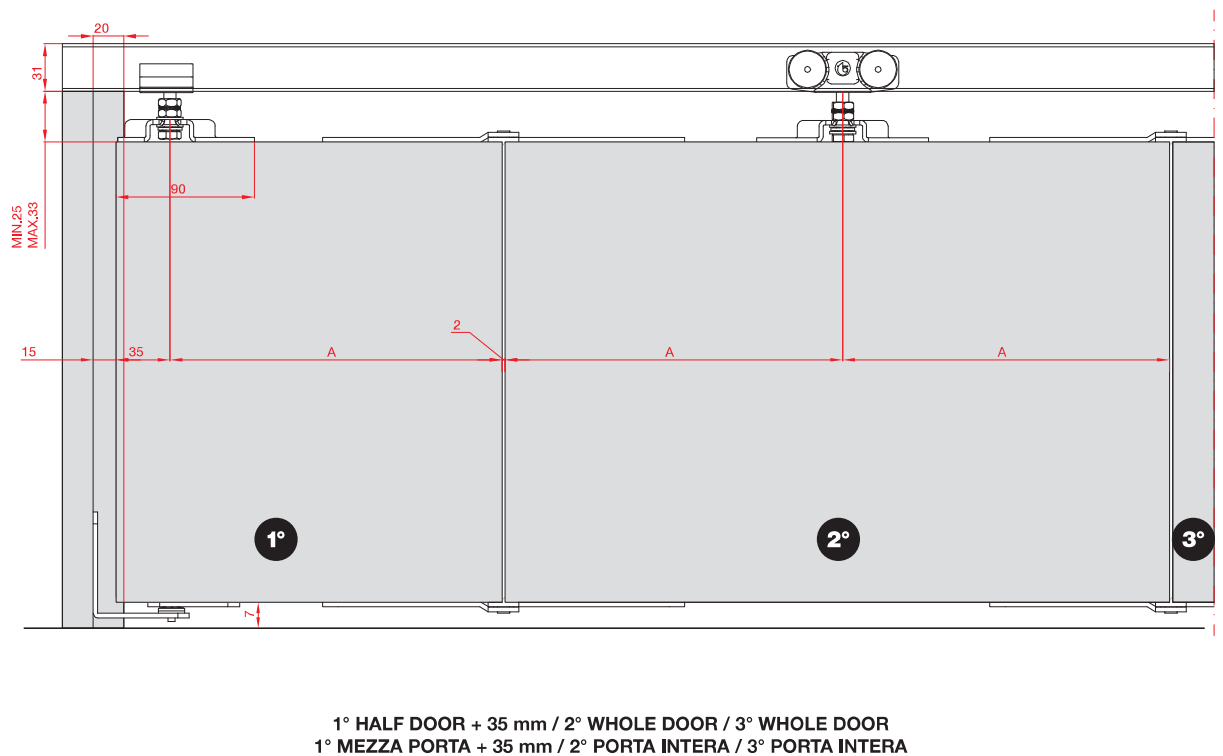

DIAGRAM FOR MOUNTING ACCESSORIES / SCHEMA DI MONTAGGIO ACCESSORI



Accordion

Accordion door
Porta pieghevole a fisarmonica



40 kg
(each door / per porta)



3 doors
3 porte



With hinges
Con cerniere

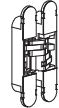
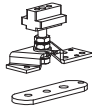
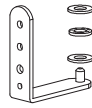

N°6
HINGES / CERNIERE ART. 1751



N°2

OLD CODE	NEW CODE	
1188/1751/N/3P	K.0224.3	4x

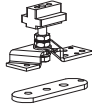
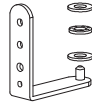

N°6
HINGES / CERNIERE ART. 1753



N°2

OLD CODE	NEW CODE	
1188/1753/N/3P	K.0224.4	4x

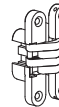
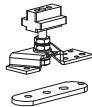
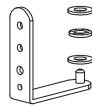

N°6
HINGES / CERNIERE ART. 1755

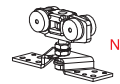

N°2

OLD CODE	NEW CODE	
1188/1755/N/3P	K.0224.5	4x

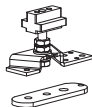
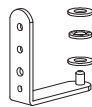

N°6
HINGES / CERNIERE ART. 1757



N°2

OLD CODE	NEW CODE	
1188/1757/PI/3P	K.0224.6	4x



40 kg
(each door / per porta)



4 doors
4 porte



With hinges
Con cerniere

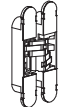
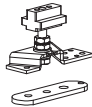
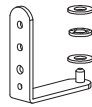

N°9
HINGES / CERNIERE ART. 1751

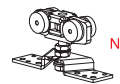

N°3

OLD CODE	NEW CODE	
1188/1751/N/4P	K.0223.3	4x

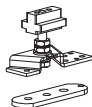
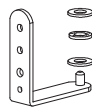

N°9
HINGES / CERNIERE ART. 1753

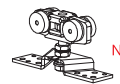

N°3

OLD CODE	NEW CODE	
1188/1753/N/4P	K.0223.4	4x

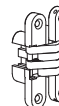
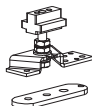
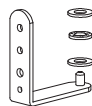

N°9
HINGES / CERNIERE ART. 1755



N°3

OLD CODE	NEW CODE	
1188/1755/N/4P	K.0223.5	4x

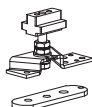
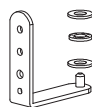

N°9
HINGES / CERNIERE ART. 1757



N°3

OLD CODE	NEW CODE	
1188/1757/PI/4P	K.0223.6	

COMPOSITION FOR ACCORDION DOORS / COMPOSIZIONI PER PORTE A FISARMONICA

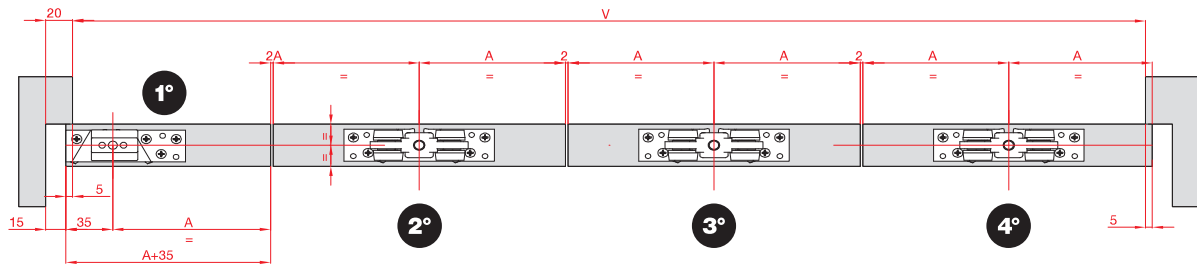
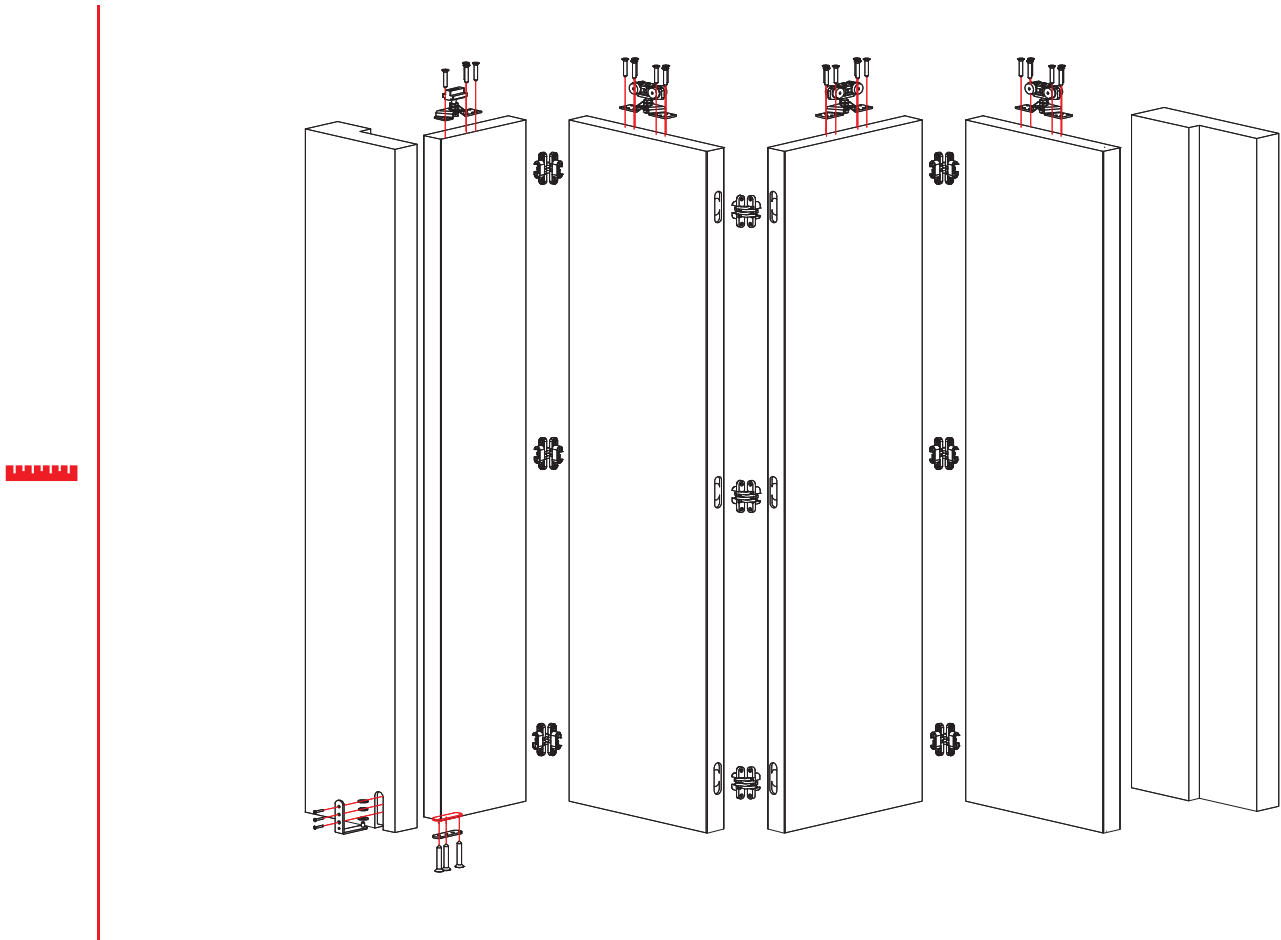

DRILLING / FORATURA



ART.1080

8 00 0.01080

8 01 0.01080



3 DOORS / PORTE - 50 kg (EACH DOOR / PER PORTA)
 $A = V + 5 + 5 - 2 - 2 - 35 : 5$

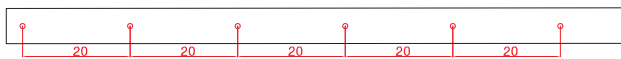

4 DOORS / PORTE - 50 kg (EACH DOOR / PER PORTA)
 $A = V + 5 + 5 - 2 - 2 - 35 : 7$