



<http://support.kesseboehmer.de/cleaningagent>

## Mounting Instructions

cleaningAGENT pull-out

## Montageanleitung

Putzmittelauszug

## Notice de montage

coulissant cleaningAGENT

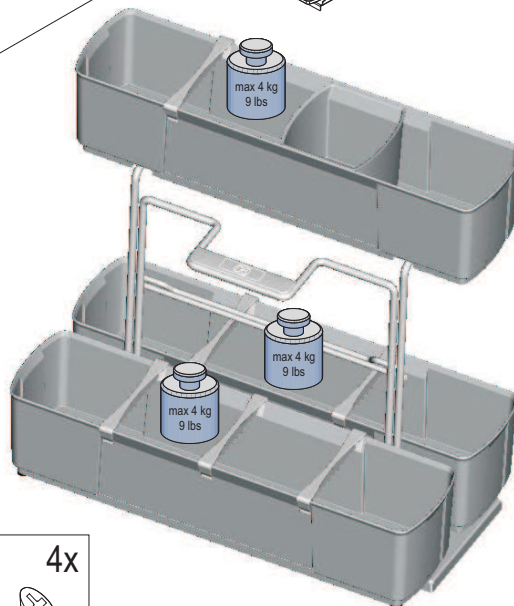
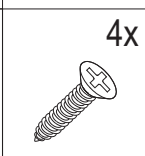
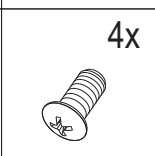
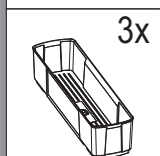
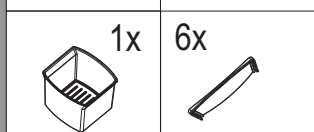
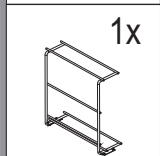
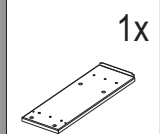
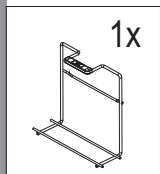
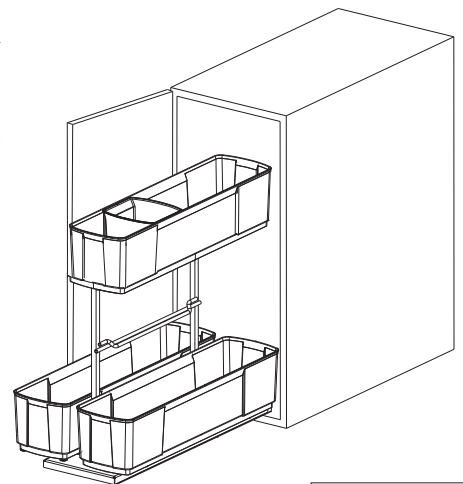
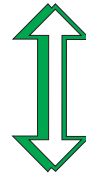
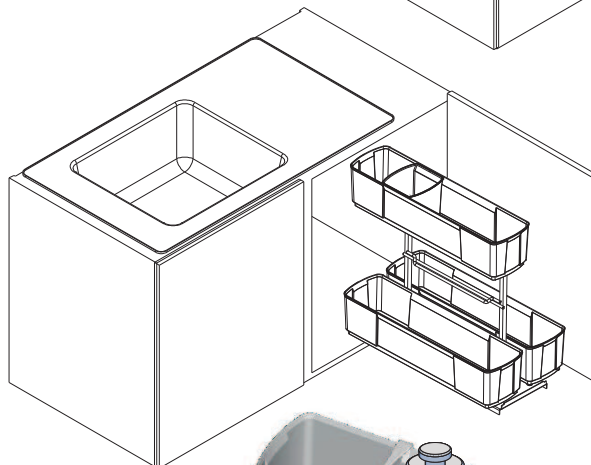
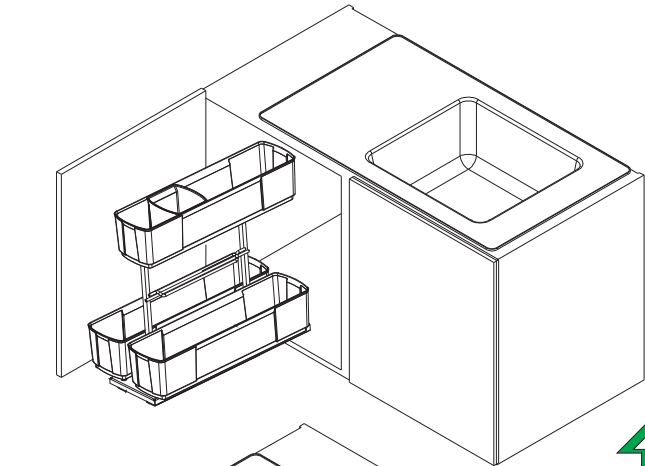

max 12 kg  
27 lbs

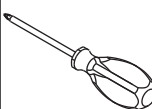
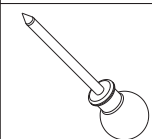
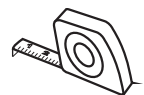

## SYMBOLE • SYMBOLS • SYMBOLES • SYMBOLI • SIMBOLOS • SIMBOLOS • MERKIT • SYMBOLER • SYMBOLY • SYMBOLE •



Warnung! • Warning! • Avertissement! • Avvertenza! • ¡Advertencia! • Aviso! • Varoitus! • Advarsel! • Výstraha! • Ostrzezenie! •



Nicht korrekt! • Incorrect! • Incorrect! • Non corretto! • ¡Incorrecto! • Incorrecto! • Väärin! • Ikke korrekt! • Nesprávně! • Nieprawidłowo!



Korrekt! • Correct! • Correct! • corretto! • ¡Correcto! • Correcto! • Oikein! • Korrekt! • Správně! • Prawidłowo!!



Fixieren/fixiert! • Secure/Secured! • Fixer/fixé • Fissare/fissato! • ¡Fijar/fijado! • Fixar/fixo! • Kiinnitä/kiinnitetty! • Spænde/sændt •



Lösen/gelöst! • Release/Released! • Détacher/détaché • Allentare/allentato! • ¡Soltar/suelto! • Soltar/solto! • Irroita/irroitettu! • Lösne/løsnet • Povolit/povolento! • Zwolnic/zwolnione!



Keinen Akkuschauber verwenden! • Do not use a cordless screwdriver! • Ne pas utiliser de tournevis à piles • Non utilizzare un avvitatore a batteria! • ¡No utilizar tladro atornillador! • Não usar aparafusadora sem fio! • Älä käyttää akkuruvinväännintä! • Brug ikke batteriskruetrækker! • Nepoužívejte akušroubovák! • Nie używac wkrtarki akumulatorowej! •



PZ2-Schraubendreher verwenden! • Use a PZ2 screwdriver! • Utiliser un tournevis Pz2 • Usare il cacciavite Pz2! • ¡Utilizar un destornillador Pz2! • Usar chave de parafusos Pz2! • Käytä PZ2-ruuviataltaa! • Brug PZ2-skrueetrækker! • Použijte krizový šroubovák Pz2! • Użyc wkretaka Pz2!



Optionales Element! • Optional element! • Élément optionnel! • Elemento opzionale! • ¡Elemento opcional! • Elemento opcional! • Valinnainen elementti! • Valgfrit element! • Voltitelný prvek! • Element opcjonalny! •



Klick-Geräusch beim Einrasten! • Audible click on engagement! • <<Clic>> lors de l'encliquetage • Quando si innesta si sente un clic! • ¡Ciaondo encaja se oye un clic! • Ruído de clique ao engatar! • Lukittuessa kuuluu klik-ääni! • Klikyd ved monterging! • Slyšitelné zacvaknutí! • Trzask przy zaskakiwaniu! •



Alle Maße in mm! • All dimensions in mm! • Toutes les dimensions en mm! • Tutte le dimensioni in mm! • ¡Todas las medidas son en mm! • Todas as medidas em mm! • Kaikki mitat mm! • Alle mal er mm! • Vsechny rozmery v mm! • Wszystkie wymiary w mm! •

Die technische Darstellung und Maßangaben -auch bei Abbildungen und Zeichnungen - sind unverbindlich. Konstruktionsverbesserungen sind vorbehalten! • Technical information and stated dimensions (including in illustrations and drawings) must not be regarded as binding. Design subject to change without notice (in interest of improvement)! • Les illustrations techniques et les cotes y compris sur les schémas et les dessins sont non contractuelles. Sous réserve d'améliorations de la construction! • Le rappresentazioni tecniche e le indicazioni delle dimensioni anche nelle figure e nei disegni non sono vincolanti. Con riserva di miglioramenti di progettazione! • Las descripciones técnicas y los datos dimensionales, inclusive los incluidos en fotos y figuras, son meramente orientativos y no vinculantes. ¡Reservado el derecho a mejoras constructivas! • As descrições técnicas e as indicações de medidas também em ilustrações e desenhos não são de natureza imperativa. Salvo melhoramentos de construção! • Tekniset piirrokset ja mitat myös kuvissa ja piirroksissa olevat ovat sitoumuksetta. Oikeus teknisiin parannuksiin pidätetään! • De tekniske fremstillinger og måleangivelser også i figurer og tegninger er vejledende. Forbehold for konstruktionsforbedringer! • Technické znázornění a rozměry i na obrázcích a výkresech jsou nezávazné. Konstrukční změny vyhrazeny! • Prezentacje techniczne i dane wymiarowe także na rysunkach są niewiązace. Zmiany konstrukcyjne zastrzeżone! •

1

mm

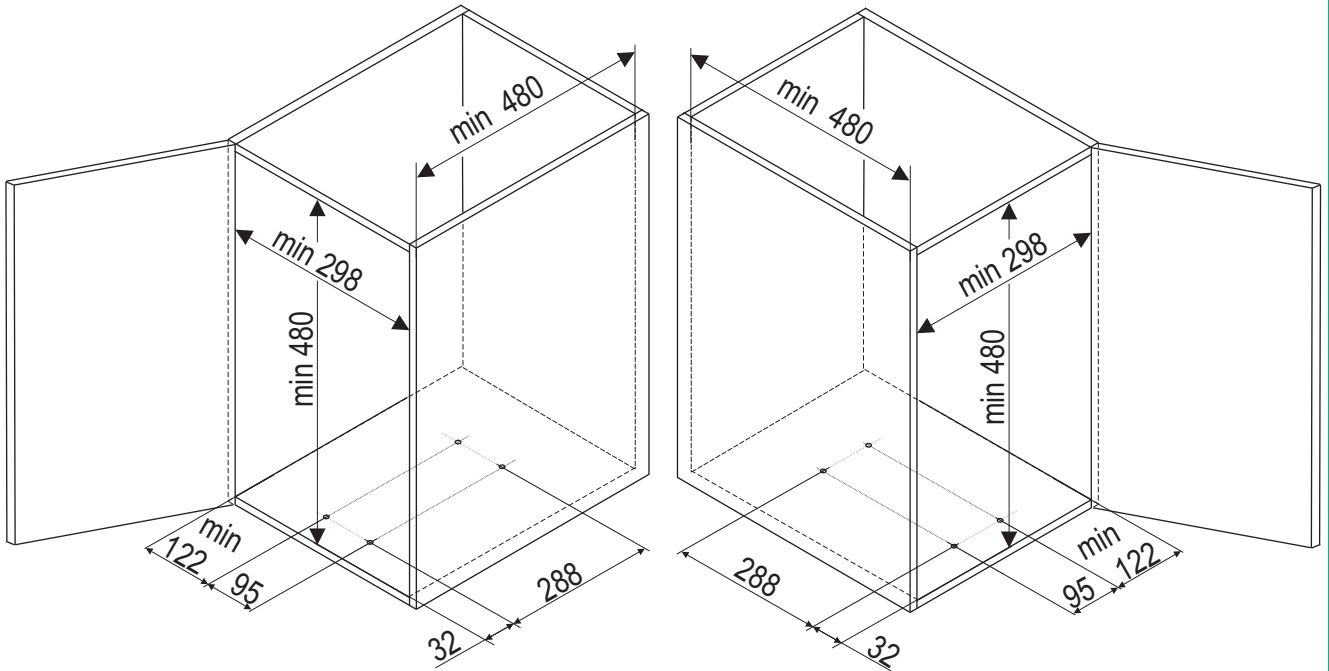

2

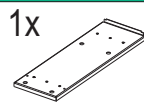

mm

**Tragekorb links**  
Portable basket on  
the left  
Panier amovible  
à gauche

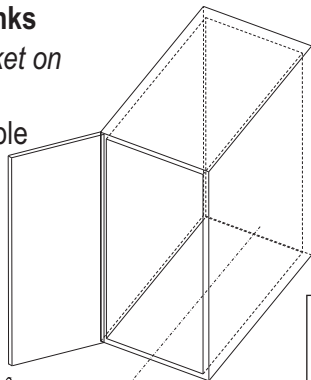

**Tragekorb rechts**  
Portable basket on  
the right  
Panier amovible  
à droite

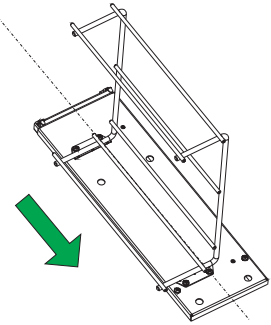
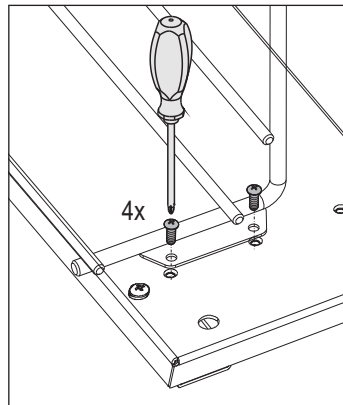
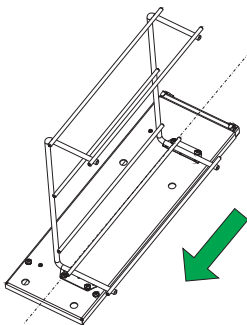
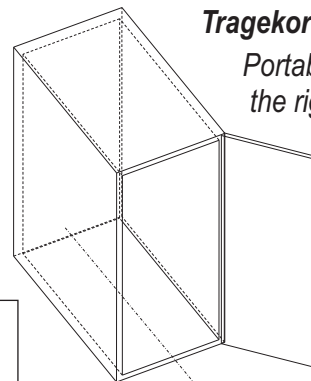

3

mm

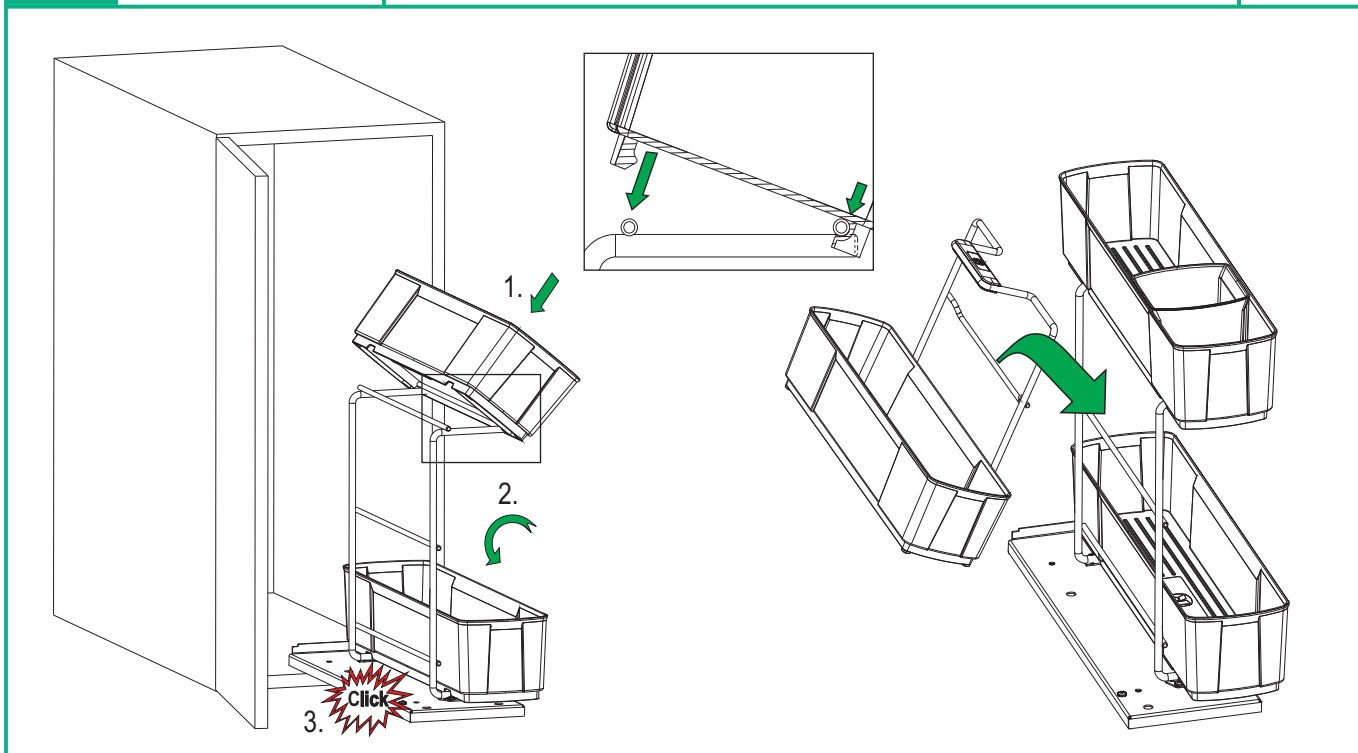

4

mm

