

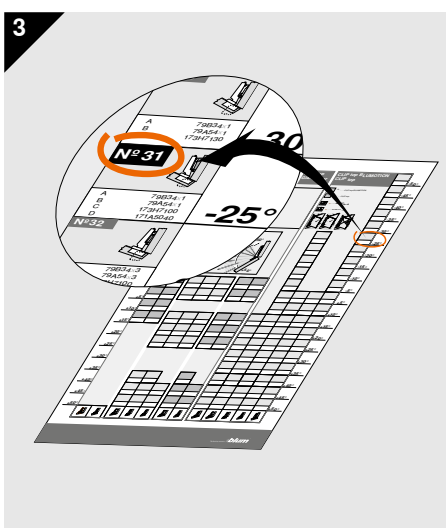

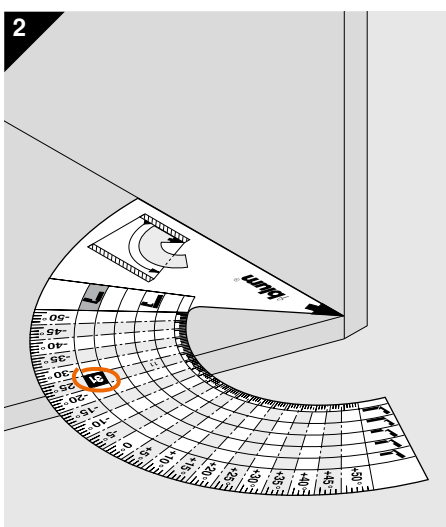

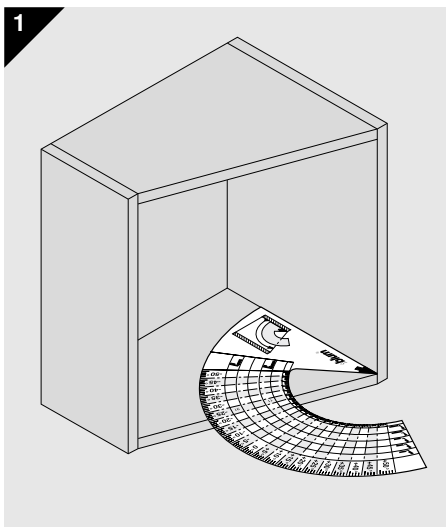











PYTHAGORAS



PYTHAGORAS

65.5810.02

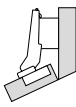
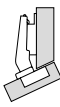
-50°					<p>N° 26</p>  <p>A 79B34:0 B 78A5450.T C 173H7100 D 171A5500</p>
-45°					<p>N° 27</p>  <p>A 79B34:0 B 78A5450.T C 173H7130</p>
-40°					<p>N° 28</p>  <p>A 79B34:0 B 78A5450.T C 173H7100 D 171A5040</p>
-35°					<p>N° 29</p>  <p>A 79B34:1 B 78A5451.T C 173H7100 D 171A5500</p>
-30°					<p>N° 30</p>  <p>A 79B34:1 B 78A5451.T C 173H7130</p>
-25°	<p>N° 11</p>  <p>A 79B34:1 B 78A5451.T C 175H7190 D 171A5070</p>				<p>N° 31</p>  <p>A 79B34:1 B 78A5451.T C 173H7100 D 171A5040</p>
-20°	<p>N° 12</p>  <p>A 79B34:3 B 78A5453.T C 175H9160 D 171A5500</p>				<p>N° 32</p>  <p>A 79B34:3 B 78A5453.T C 173H7100 D 171A5000</p>
-15°	<p>N° 13</p>  <p>A 79B34:3 B 78A5453.T C 175H7190.22</p>				<p>N° 33</p>  <p>A 79B34:3 B 78A5453.T C 173H7100</p>
-10°	<p>N° 14</p>  <p>A 79B34:3 B 78A5453.T C 175H7190 D 171A5070</p>				<p>N° 34</p>  <p>A 79B34:3 B 78A5453.T C 173H7100 D 171A5010</p>
-5°	<p>N° 15</p>  <p>A 71B96:0 B 70T9650.TL C 173H7100 D 171A5500</p>				<p>N° 35</p>  <p>A 71B95:0 B 70T9550.TL C 173H7100 D 171A5500</p>
					 

PYTHAGORAS



	N° 16 A 71B97.0 B 7079750.TL C 173H7100 D 171A5010	N° 46 A 71B96.0 B 7079650.TL C 173H7100 D 171A5070	N° 1 A 71B95.0 B 7079550.TL C 173H7100 D 171A5010	N° 36 A 71B95.0 B 7079550.TL C 173H7100 D 171A5010	+5°
	N° 17 A 79B94.4 B 78A9454.T C 175H7190.22 D 171A5500	N° 47 A 79B94.4 B 78A9454.T C 175H7190.22 D 171A5500	N° 2 A 79B94.4 B 78A9454.T C 173H7100 D 171A5500	N° 37 A 79B94.4 B 78A9454.T C 173H7100 D 171A5500	+10°
N° 55 A 79B95.5 B 78A9555.T C 173H7100 D 171A5500	N° 18 A 79B95.5 B 78A9555.T C 175H7190 D 171A5500	N° 48 A 79B95.5 B 78A9555.T C 173H7190 D 171A5500	N° 3 A 79B94.4 B 78A9454.T C 175H7190	N° 38 A 79B94.4 B 78A9454.T C 175H9160	+15°
N° 56 A 79B95.5 B 78A9555.T C 175H9160	N° 19 A 79B95.5 B 78A9555.T C 175H7190.22	N° 49 A 79B95.5 B 78A9555.T C 175H7190	N° 4 A 79B95.5 B 78A9555.T C 173H7100	N° 39 A 79B94.4 B 78A9454.T C 173H7100 D 171A5070	+20°
N° 57 A 79B95.6 B 78A9556.T C 173H7100 D 171A5500	N° 20 A 79B95.6 B 78A9556.T C 175H7190 D 171A5500	N° 50 A 79B95.6 B 78A9556.T C 173H7100 D 171A5500	N° 5 A 79B95.5 B 78A9555.T C 173H7100 D 171A5010	N° 40 A 79B94.6 B 78A9456.T C 173H7100 D 171A5500	+25°
N° 58 A 79B95.6 B 78A9556.T C 173H7190	N° 21 A 79B95.6 B 78A9556.T C 175H7190.22	N° 51 A 79B95.6 B 78A9556.T C 175H7190	N° 6 A 79B95.6 B 78A9556.T C 173H7100	N° 41 A 79B94.6 B 78A9456.T C 175H9160	+30°
N° 59 A 79B95.6 B 78A9556.T C 173H7100 D 171A5040	N° 22 A 79B95.6 B 78A9556.T C 175H7190.22 D 171A5010	N° 52 A 79B95.6 B 78A9556.T C 173H7100 D 171A5070	N° 7 A 79B95.6 B 78A9556.T C 173H7100 D 171A5010	N° 42 A 79B94.6 B 78A9456.T C 173H7100 D 171A5070	+35°
N° 109 A 79B94.8 B 78A9458.T C 175H7190 D 171A5010	N° 23 A 79B96.8 B 78A9558.T C 175H7190 D 171A5500	N° 108 A 79B94.8 B 78A9458.T C 175H7190 D 171A5040	N° 8 A 79B94.8 B 78A9458.T C 175H9160 D 171A5500	N° 43 A 79B94.8 B 78A9458.T C 173H7100 D 171A5500	+40°
N° 60 A 79B96.8 B 78A9658.T C 173H7100	N° 24 A 79B35.8 B 7815550 C 175H7190.22	N° 53 A 79B96.8 B 78A9658.T C 173H7100	N° 9 A 79B35.8 B 7815550 C 173H7100	N° 44 A 79B94.8 B 78A9458.T C 175H9160	+45°
N° 61 A 79B96.8 B 78A9658.T C 173H7100 D 171A5010	N° 25 A 79B96.8 B 78A9658.T C 175H7190 D 171A5070	N° 54 A 79B96.8 B 78A9658.T C 173H7100 D 171A5010	N° 10 A 79B35.8 B 7815550 C 173H7100 D 171A5010	N° 45 A 79B94.8 B 78A9458.T C 173H7100 D 171A5070	+50°
 A 79B96.8 B 78A9658.T C 173H7100 D 171A5010	 A 79B96.8 B 78A9658.T C 175H7190 D 171A5070	 A 79B96.8 B 78A9658.T C 173H7100 D 171A5010	 A 79B35.8 B 7815550 C 173H7100 D 171A5010	 A 79B94.8 B 78A9458.T C 173H7100 D 171A5070	

PYTHAGORAS

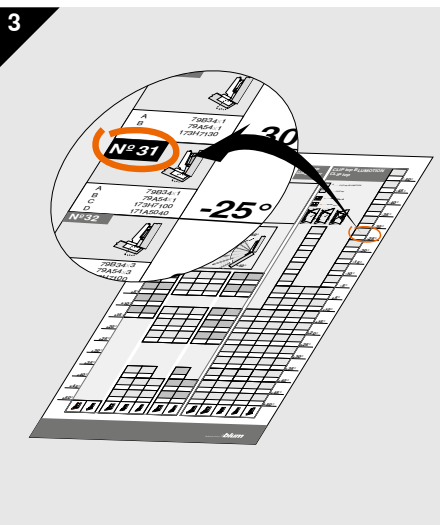
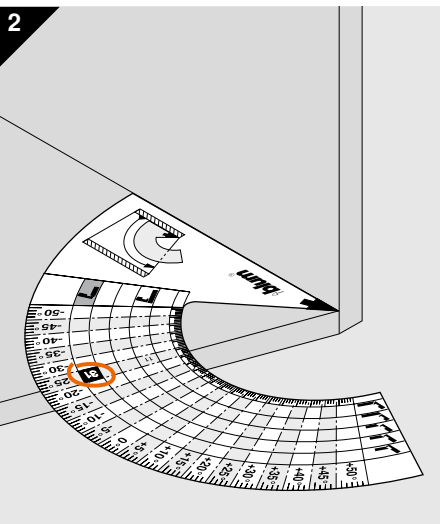
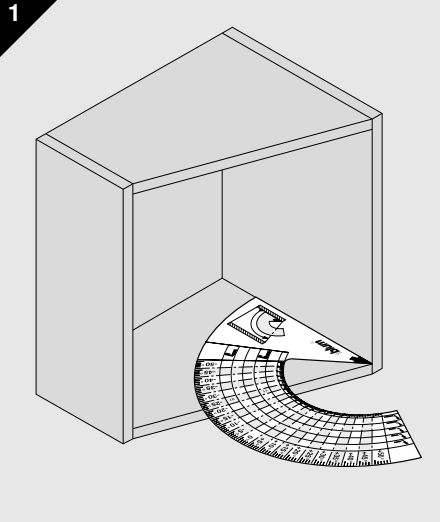



PYTHAGORAS

65.5810.02

	<table border="1"> <tr> <th>N° 106</th> <th>N° 107</th> </tr> <tr> <td></td> <td></td> </tr> <tr> <td>A 71B4500C</td> <td>A 71B4500C</td> </tr> <tr> <td>B 70T4500CTL</td> <td>B 70T4500CTL</td> </tr> <tr> <td>C 173H7100</td> <td>C 173H7100</td> </tr> <tr> <td>D 171A5500</td> <td>D 171A5500</td> </tr> </table>	N° 106	N° 107			A 71B4500C	A 71B4500C	B 70T4500CTL	B 70T4500CTL	C 173H7100	C 173H7100	D 171A5500	D 171A5500	<table border="1"> <tr> <th>N° 114</th> <th>N° 110</th> </tr> <tr> <td></td> <td></td> </tr> <tr> <td>A 71B453T</td> <td>A 71B453T</td> </tr> <tr> <td>B 70T453T.TL</td> <td>B 70T453T.TL</td> </tr> <tr> <td>C 173H7100</td> <td>C 173H7100</td> </tr> <tr> <td>D 171A5500</td> <td>D 171A5500</td> </tr> </table>	N° 114	N° 110			A 71B453T	A 71B453T	B 70T453T.TL	B 70T453T.TL	C 173H7100	C 173H7100	D 171A5500	D 171A5500
N° 106	N° 107																									
A 71B4500C	A 71B4500C																									
B 70T4500CTL	B 70T4500CTL																									
C 173H7100	C 173H7100																									
D 171A5500	D 171A5500																									
N° 114	N° 110																									
A 71B453T	A 71B453T																									
B 70T453T.TL	B 70T453T.TL																									
C 173H7100	C 173H7100																									
D 171A5500	D 171A5500																									
-5°	<table border="1"> <tr> <th>N° 103</th> <th>N° 100</th> </tr> <tr> <td></td> <td></td> </tr> <tr> <td>A 71B4500C</td> <td>A 71B4500C</td> </tr> <tr> <td>B 70T4500CTL</td> <td>B 70T4500CTL</td> </tr> <tr> <td>C 173H7100</td> <td>C 173H7100</td> </tr> <tr> <td>D 171A5010</td> <td>D 171A5010</td> </tr> </table>	N° 103	N° 100			A 71B4500C	A 71B4500C	B 70T4500CTL	B 70T4500CTL	C 173H7100	C 173H7100	D 171A5010	D 171A5010	<table border="1"> <tr> <th>N° 115</th> <th>N° 111</th> </tr> <tr> <td></td> <td></td> </tr> <tr> <td>A 71B453T</td> <td>A 71B453T</td> </tr> <tr> <td>B 70T453T.TL</td> <td>B 70T453T.TL</td> </tr> <tr> <td>C 173H7100</td> <td>C 173H7100</td> </tr> <tr> <td>D 171A5010</td> <td>D 171A5010</td> </tr> </table>	N° 115	N° 111			A 71B453T	A 71B453T	B 70T453T.TL	B 70T453T.TL	C 173H7100	C 173H7100	D 171A5010	D 171A5010
N° 103	N° 100																									
A 71B4500C	A 71B4500C																									
B 70T4500CTL	B 70T4500CTL																									
C 173H7100	C 173H7100																									
D 171A5010	D 171A5010																									
N° 115	N° 111																									
A 71B453T	A 71B453T																									
B 70T453T.TL	B 70T453T.TL																									
C 173H7100	C 173H7100																									
D 171A5010	D 171A5010																									
+5°	<table border="1"> <tr> <th>N° 104</th> <th>N° 101</th> </tr> <tr> <td></td> <td></td> </tr> <tr> <td>A 71B4500C</td> <td>A 71B4500C</td> </tr> <tr> <td>B 70T4500CTL</td> <td>B 70T4500CTL</td> </tr> <tr> <td>C 173H7100</td> <td>C 173H7100</td> </tr> <tr> <td>D (2x) 171A5010</td> <td>D (2x) 171A5010</td> </tr> </table>	N° 104	N° 101			A 71B4500C	A 71B4500C	B 70T4500CTL	B 70T4500CTL	C 173H7100	C 173H7100	D (2x) 171A5010	D (2x) 171A5010	<table border="1"> <tr> <th>N° 116</th> <th>N° 112</th> </tr> <tr> <td></td> <td></td> </tr> <tr> <td>A 71B453T</td> <td>A 71B453T</td> </tr> <tr> <td>B 70T453T.TL</td> <td>B 70T453T.TL</td> </tr> <tr> <td>C 173H7100</td> <td>C 173H7100</td> </tr> <tr> <td>D (2x) 171A5010</td> <td>D (2x) 171A5010</td> </tr> </table>	N° 116	N° 112			A 71B453T	A 71B453T	B 70T453T.TL	B 70T453T.TL	C 173H7100	C 173H7100	D (2x) 171A5010	D (2x) 171A5010
N° 104	N° 101																									
A 71B4500C	A 71B4500C																									
B 70T4500CTL	B 70T4500CTL																									
C 173H7100	C 173H7100																									
D (2x) 171A5010	D (2x) 171A5010																									
N° 116	N° 112																									
A 71B453T	A 71B453T																									
B 70T453T.TL	B 70T453T.TL																									
C 173H7100	C 173H7100																									
D (2x) 171A5010	D (2x) 171A5010																									
+10°	<table border="1"> <tr> <th>N° 105</th> <th>N° 102</th> </tr> <tr> <td></td> <td></td> </tr> <tr> <td>A 71B4500C</td> <td>A 71B4500C</td> </tr> <tr> <td>B 70T4500CTL</td> <td>B 70T4500CTL</td> </tr> <tr> <td>C 173H7100</td> <td>C 173H7100</td> </tr> <tr> <td>D (3x) 171A5010</td> <td>D (3x) 171A5010</td> </tr> </table>	N° 105	N° 102			A 71B4500C	A 71B4500C	B 70T4500CTL	B 70T4500CTL	C 173H7100	C 173H7100	D (3x) 171A5010	D (3x) 171A5010	<table border="1"> <tr> <th>N° 117</th> <th>N° 113</th> </tr> <tr> <td></td> <td></td> </tr> <tr> <td>A 71B453T</td> <td>A 71B453T</td> </tr> <tr> <td>B 70T453T.TL</td> <td>B 70T453T.TL</td> </tr> <tr> <td>C 173H7100</td> <td>C 173H7100</td> </tr> <tr> <td>D (3x) 171A5010</td> <td>D (3x) 171A5010</td> </tr> </table>	N° 117	N° 113			A 71B453T	A 71B453T	B 70T453T.TL	B 70T453T.TL	C 173H7100	C 173H7100	D (3x) 171A5010	D (3x) 171A5010
N° 105	N° 102																									
A 71B4500C	A 71B4500C																									
B 70T4500CTL	B 70T4500CTL																									
C 173H7100	C 173H7100																									
D (3x) 171A5010	D (3x) 171A5010																									
N° 117	N° 113																									
A 71B453T	A 71B453T																									
B 70T453T.TL	B 70T453T.TL																									
C 173H7100	C 173H7100																									
D (3x) 171A5010	D (3x) 171A5010																									
+15°	<p>* Zur Befestigung des Scharniers an die Front wird zusätzlich die CRISTALLO-Topplatte benötigt:</p> <p>* The CRISTALLO adhesion plate is also necessary to fix the hinge to the front:</p> <p>* Pour fixer la charnière sur la face, il est nécessaire d'ajouter la semelle de boîtier CRISTALLO :</p> <p>* Per fissare la cerniera al frontale occorre in aggiunta il portafondello CRISTALLO:</p> <p>* Para la fijación de la bisagra en el frente se requiere adicionalmente la placa de cazoleta CRISTALLO:</p>																									
	70T4568C																									

- Standard
 - standard
 - standard
 - standard
 - estándar
- CRISTALLO
- Dünne Türen
 - Thin doors
 - Portes minces
 - Ante sottili
 - Puertas delgadas

 A CLIP top BLUMOTION

 B CLIP top ohne Feder
 CLIP top unsprung
 CLIP top sans ressort
 CLIP top senza molla
 CLIP top sin muelle

 x INSERTA = 9

 x Schrauben = 5
 screw-on
 à visser
 viti
 por atornillado

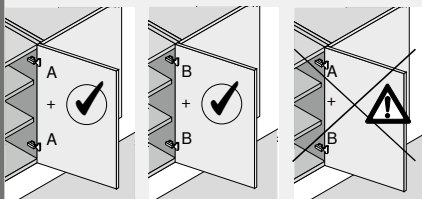

 C Montageplatte
 Mounting plate
 Embase
 Piastrina di premontaggio
 Base

 D Winkelkeil
 Angled spacer
 Cale d'angle
 Cuneo ad angolo
 Cuña de ángulo

Julius Blum GmbH
Furniture Fittings Mfg.
6973 Höchst, Austria
Tel.: +43 5578 705-0
Fax: +43 5578 705-44
E-mail: info@blum.com
www.blum.com

Our sites in Austria, Poland and China are certified to the international standards mentioned below.
Our site in the USA is certified to ISO 9001.
Our site in Brazil is certified to ISO 9001 and ISO 14001.



The Blum logo, consisting of a stylized arrow pointing upwards and to the right, followed by the word "blum" in a bold, lowercase, sans-serif font, with a registered trademark symbol (®) to the upper right.



Look for our
FSC™-certified
products

All content is copyrighted by Blum.
Subject to technical modifications and changes to the range without notice.
IDNR: 519.138.2 · FO-163/1 EN-AL/06.21