



MAORI



12 mm min. 12mm

UNI EN 14749/05

INSTALLATION AND ASSEMBLING

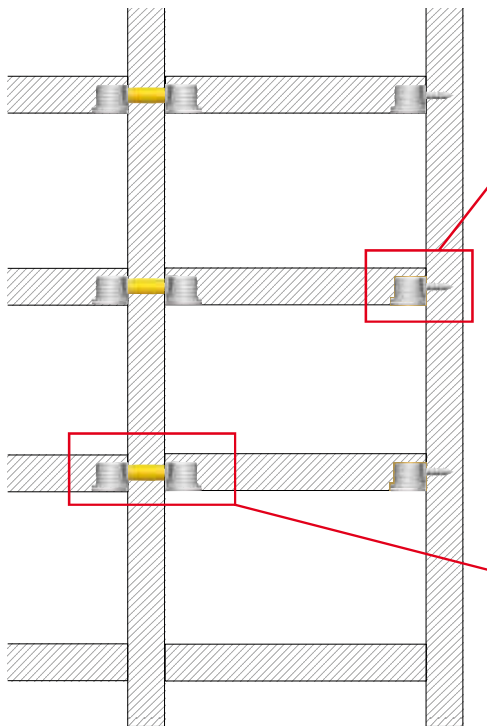
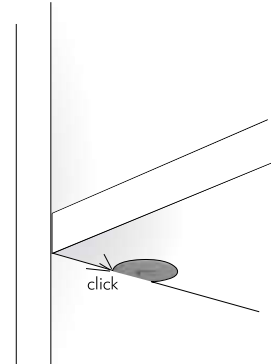
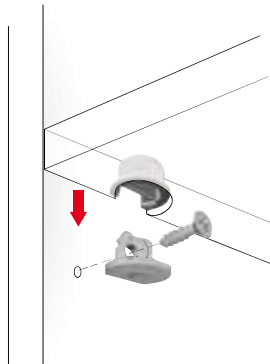
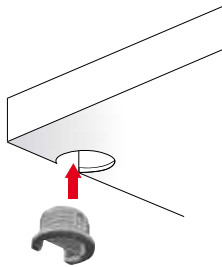

Assembling with alternative fixing options.

Assembling with pre-inserted spreading bush and screw to avoid hole damaging for shelf repositioning.

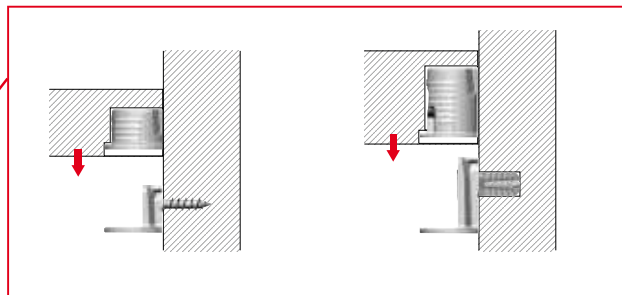

SPECIAL APPLICATION FOR SIDE PANEL 12 mm THICK:

Through hole fixing with metric sleeve.

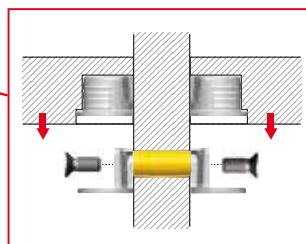

OPTIONAL FIXING (12mm thick version excluded):

To achieve much more horizontal connection.

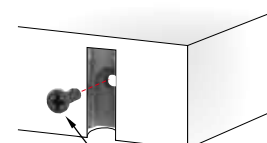

Optional fixing with pan head wood screw Ø 3 x 16 mm.



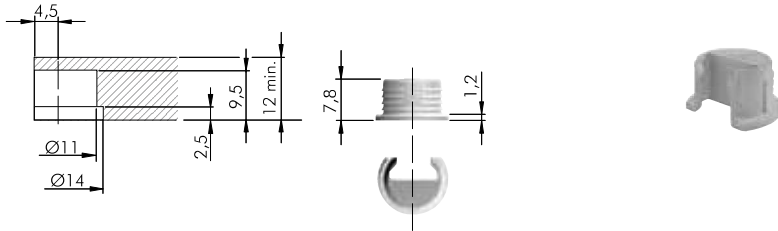

Also suitable for top and bottom panels when a back panel is used.

MAORI 12 mm

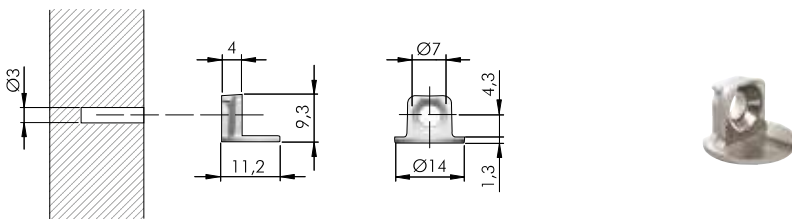







EP	 = 30.000 pcs.
 11701010L	

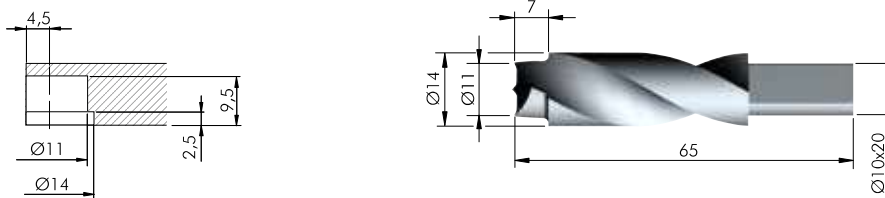

 = Ø 3 mm	
ZA	 = 5000 pcs.
 11702010YA	



DRILL BIT FOR MAORI 12 mm

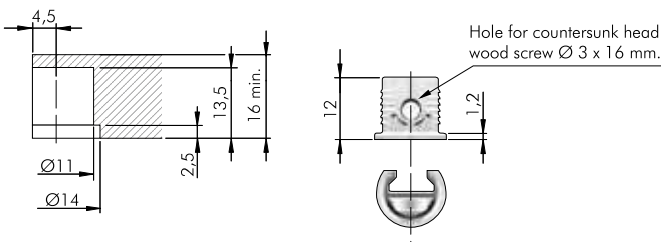

HSS	 = on request
 1175201000	
 1175205000	 

MAORI 16 mm



EP	 = 5000 pcs.
 11701040L	

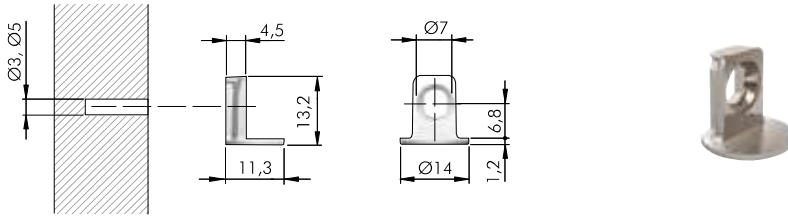

= Ø 3, Ø 5 mm +

ZA

= 5000 pcs.



11704010YA

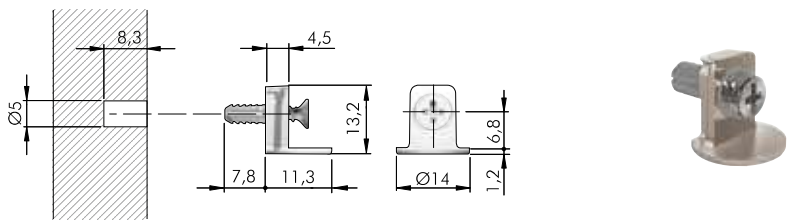

= Ø 5 mm +

= PZ2

ZA

ST

EP

= 2500 pcs.



11704030YA

DRILL BIT FOR MAORI 16 mm

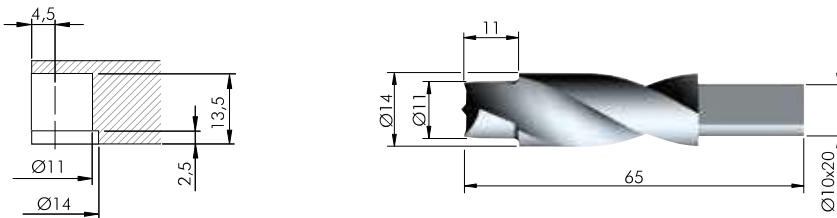

HSS = on request



1175202000

R

1175206000

L

MAORI 18 - 19 mm

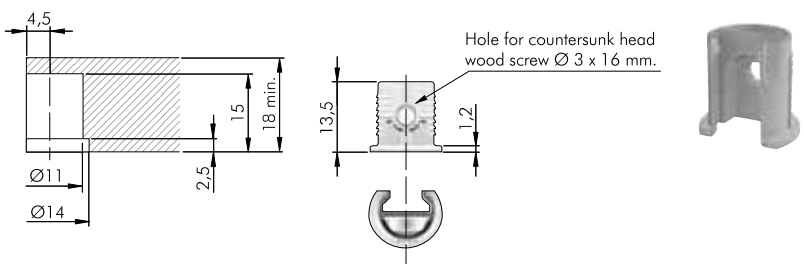

EP

= 20.000 pcs.



11701070IL

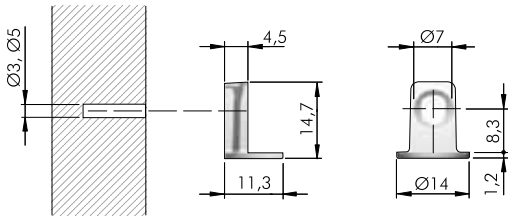

= Ø 3, Ø 5 mm +

= 5000 pcs.

11710010YA

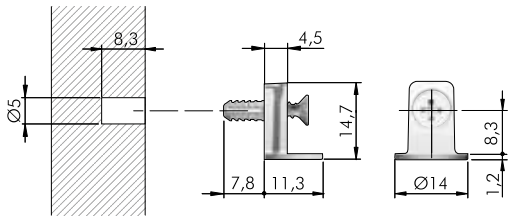

= Ø 5 mm +

= PZ2

= 5000 pcs.

11710030YA

DRILL BIT FOR MAORI 18 - 19 mm

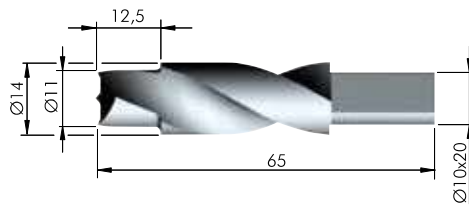
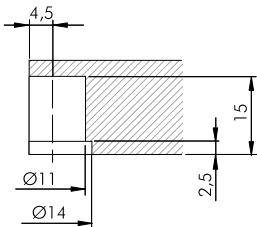

= on request

1175203000

1175207000

MAORI 25 mm

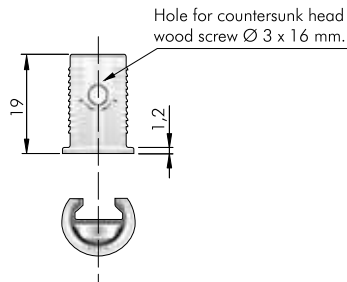
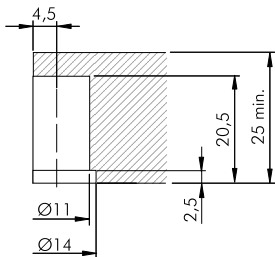

= 10.000 pcs.

11701100IL

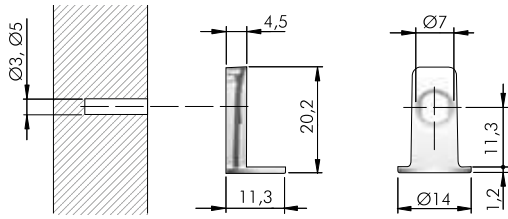

= Ø 3, Ø 5 mm +

ZA

= 2500 pcs.



11716010YA

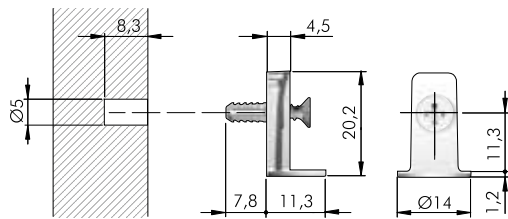

= Ø 5 mm +

= PZ2

ZA

ST

EP

= 2500 pcs.



11716030YA

MAORI 29 mm

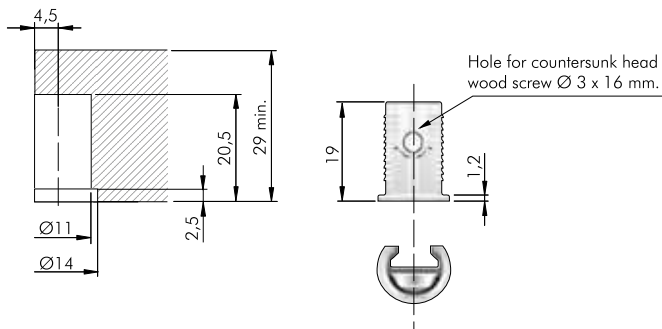

EP

= 10.000 pcs.



11701100IL

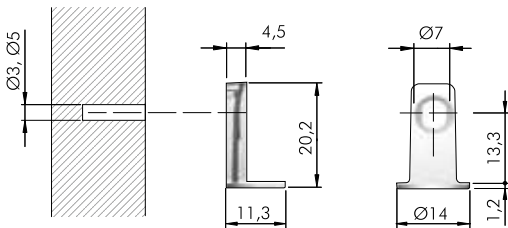

= Ø 3, Ø 5 mm +

ZA

= 5000 pcs.



11722010YA

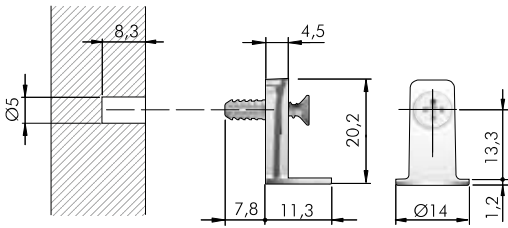

= Ø 5 mm +

= PZ2

= 2500 pcs.

11722030YA

DRILL BIT FOR MAORI 25, 29 mm

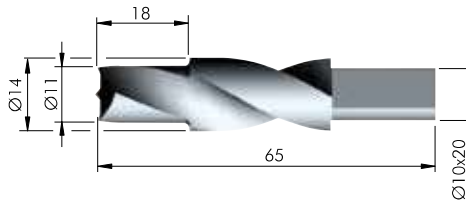
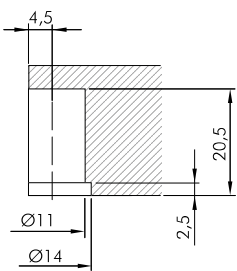

= on request

1175204000

1175208000

MAORI FIXING ACCESSORIES

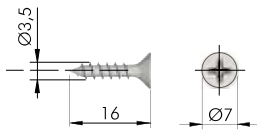

= Ø 3 mm +

= PZ2

= 10.000 pcs.

60101390ZN

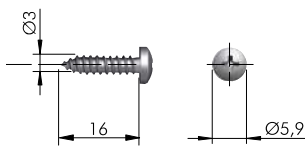

= Ø 2,5 mm +

= PZ2

= 100 pcs.

60103040ZN

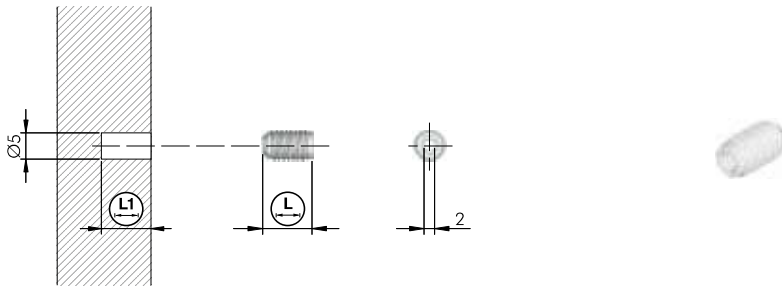

= Ø 5 mm

EPn

= 5000 pcs.



20302020AA

20302030AA



9,5

13



11,5

15

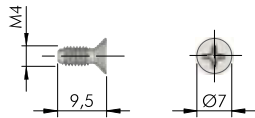

= PZ2



= M4

ST

= 15.000 pcs.



11750010ZN

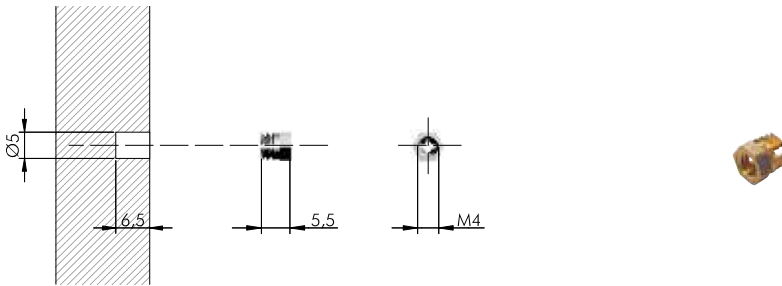

= Ø 5 mm

= M4

BR

= 5000 pcs.



20502000HL

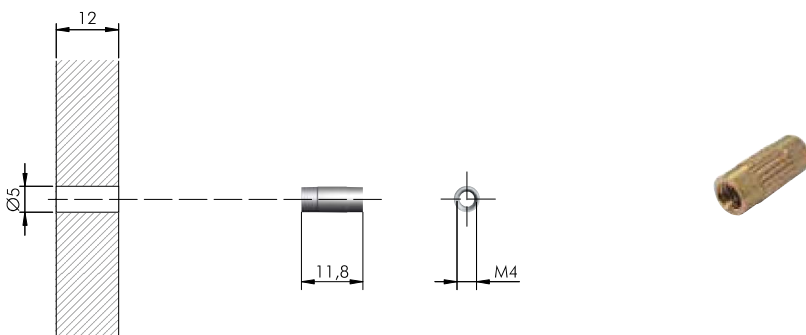

= Ø 5 mm

= 12 mm = M4

BR

= 5000 pcs.



20801000HL