



Frontalino

Front facing sliding doors
Ante scorrevoli a posizione frontale





EXTERNAL OVERLAPPING DOORS
ANTE SOVRAPPOSTE ESTERNE

Frontalino

Front facing sliding doors system, easy to install thanks to its integrated doors adjustment system.

Sistema per ante scorrevoli a posizione frontale, semplice da installare grazie al suo sistema integrato di regolazione.



Integrated adjustment system

Easy to install

Frontalino is an **adjustable sliding system with extremely reduced encumbrance**, designed for wardrobes with external overlapped doors weighing up to 30 kg.

Frontalino system stands out for its particularly **easy installation** and for its **integrated doors adjustment system**.

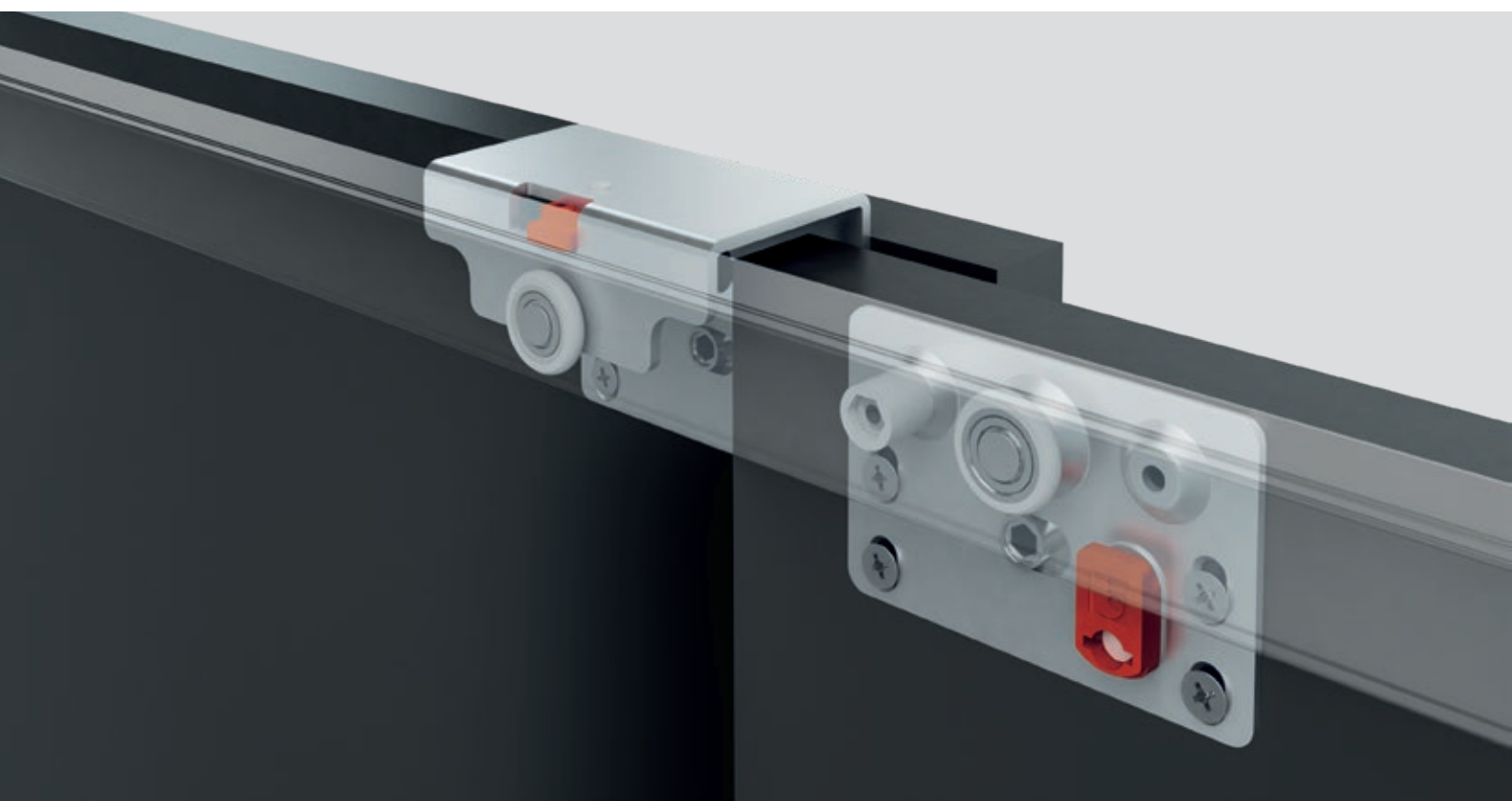

Sistema di regolazione integrato

Facile da installare

Il sistema Frontalino è un **sistema scorrevole regolabile con ingombro estremamente ridotto**, progettato per armadi con ante sovrapposte con portata massima fino a 30 kg.

Il sistema Frontalino si distingue per la sua **installazione** particolarmente **semplice** e per il suo **sistema integrato di regolazione dell'anta**.

Frontalino

COMPLETE BOX KIT / KIT COMPLETO IN SCATOLA



K		Complete kit / Kit completo	
1091		N.2 Door thickness 22 mm N.2 Spessore anta 22 mm	
1092		N.3 Door thickness 22 mm N.3 Spessore anta 22 mm	
1093		N.2 Door thickness 28 mm N.2 Spessore anta 28 mm	
1094		N.3 Door thickness 28 mm N.3 Spessore anta 28 mm	
			1 N.1 Internal standard stopper LH + N.1 External standard stopper RH N.1 Fermo standard interno SX + N.1 Fermo standard esterno DX
			2 N.1 Internal standard stopper RH + N.1 External standard stopper LH N.1 Fermo standard interno DX + N.1 Fermo standard esterno SX
			3 N.2 External standard stoppers + N.1 Internal standard stopper RH N.2 Fermi standard esterni + N.1 Fermo standard interno DX
			4 N.2 External standard stoppers + N.1 Internal standard stopper LH N.2 Fermi standard esterni + N.1 Fermo standard interno SX
			5 N.2 External standard stoppers + N.2 Central standard stopper ART.1195 N.2 Fermi standard esterni + N.1 Fermo standard centrale ART.1195

EXAMPLE / ESEMPIO

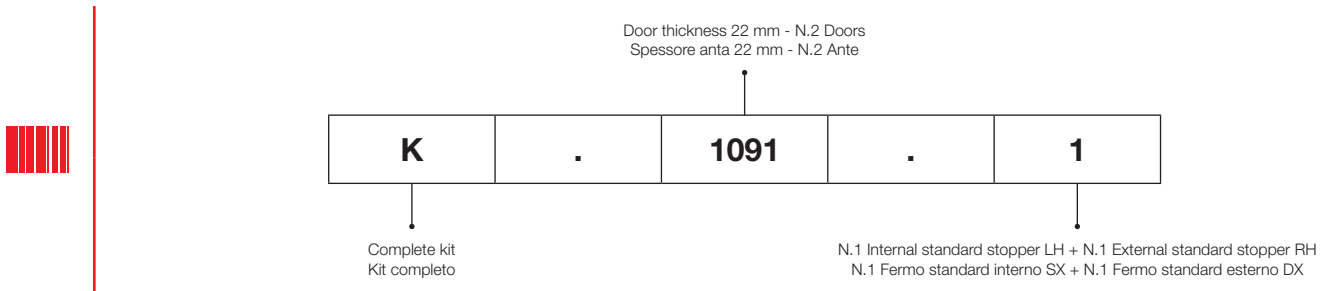

Tracks / Binari

ALUMINUM FINISHES CODES / CODICI FINITURE ALLUMINIO



CODE / CODICE	FINISH COLOR / COLORE FINITURA		STANDARD
8 00 0.0	00	Raw / Mill Finish / Neutro / Grezzo	
8 01 0.0	01	Anodized Silver / Argento	

Frontalino

Front facing sliding doors
Ante scorrevoli a posizione frontale

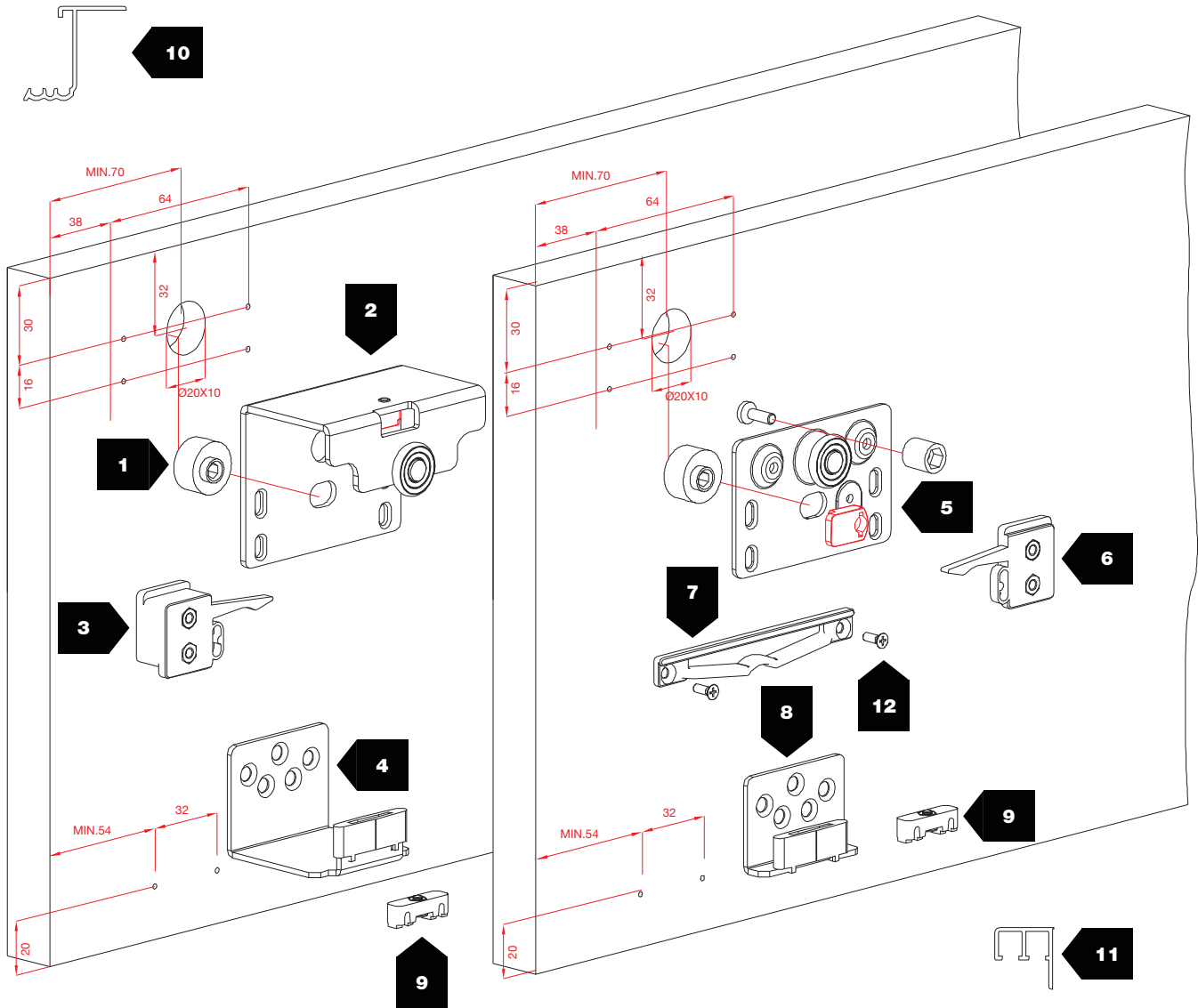





22 ÷ 28 mm



30 kg

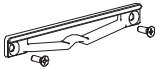
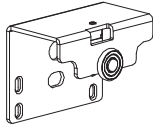
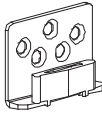
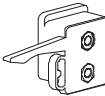

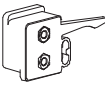
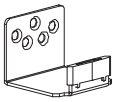
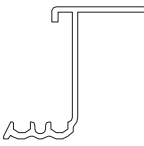
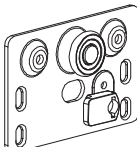
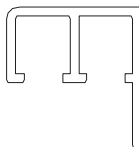
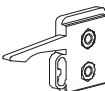
35 mm

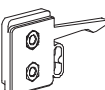
N°			kg	→ ←	N°			kg	→ ←
1	1199		—	22±28 mm	7	1195		30	22±28 mm
2	1193		30	22 mm	8	1196		30	22±28 mm
	1194			28 mm					
3	1182/D		30	22±28 mm	9	1072		30	22±28 mm
	1182/S								
4	1197		30	22 mm	10	1190 8 00 0.01190 8 01 0.01190		30	22±28 mm
	1198			28 mm					
5	1192		30	22±28 mm	11	1191 8 00 0.01191 8 01 0.01191		30	22±28 mm
6	1181/D		30	22±28 mm	12	528		—	22±28 mm
	1181/S								

Frontalino

Front facing sliding doors
Ante scorrevoli a posizione frontale



Adjustable doors
Ante regolabili



N.2 Doors
N.2 Ante



Sliding guide
Guida scivolante



Ref. Positioning
Rif. Posizionamento

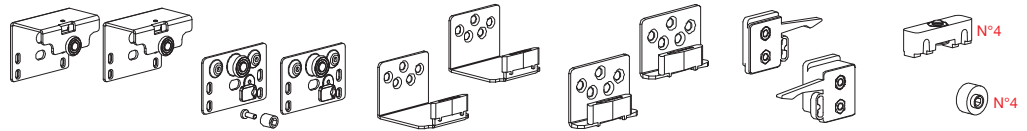

OLD CODE	NEW CODE		MAX
1193-1192-A2	K.1091.1	A	22 mm
1194-1192-A2	K.1093.1		28 mm



Adjustable doors
Ante regolabili



N.2 Doors
N.2 Ante



Sliding guide
Guida scivolante



Ref. Positioning
Rif. Posizionamento

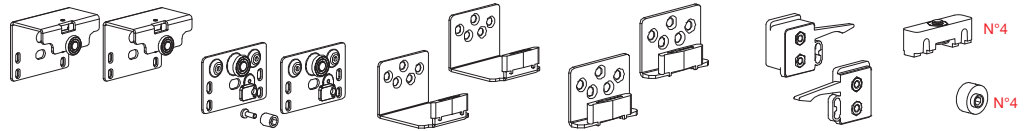

OLD CODE	NEW CODE		MAX
1193-1192-B2	K.1091.2	A	22 mm
1194-1192-B2	K.1093.2		28 mm



Adjustable doors
Ante regolabili



N.3 Doors
N.3 Ante



Sliding guide
Guida scivolante



Ref. Positioning
Rif. Posizionamento

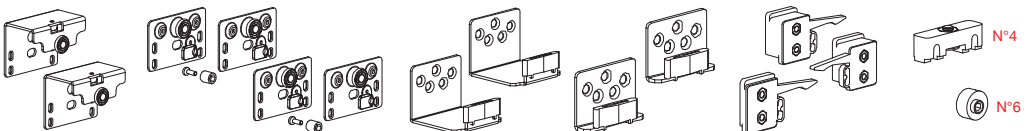

OLD CODE	NEW CODE		MAX
1193-1192-C3	K.1092.4	A	22 mm
1194-1192-C3	K.1094.4		28 mm



Adjustable doors
Ante regolabili



N.3 Doors
N.3 Ante



Sliding guide
Guida scivolante



Ref. Positioning
Rif. Posizionamento

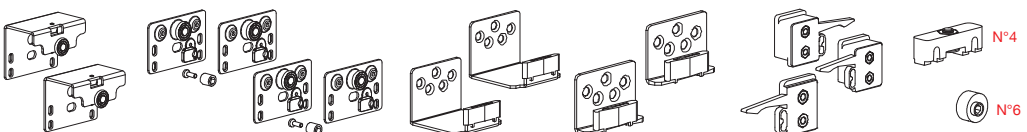

OLD CODE	NEW CODE		MAX
1193-1192-D3	K.1092.3	A	22 mm
1194-1192-D3	K.1094.3		28 mm



Adjustable doors
Ante regolabili



N.3 Doors
N.3 Ante



Sliding guide
Guida scivolante



With central lock
Con fermo centrale
ART. 1195



Ref. Positioning
Rif. Posizionamento

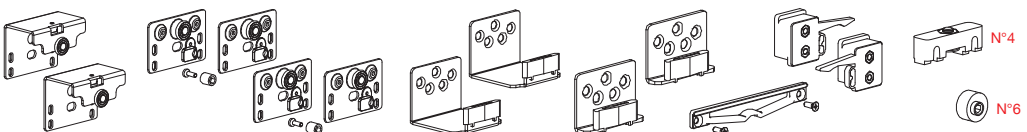

OLD CODE	NEW CODE		MAX
1193-1192-E3	K.1092.5	A	22 mm
1194-1192-E3	K.1094.5		28 mm

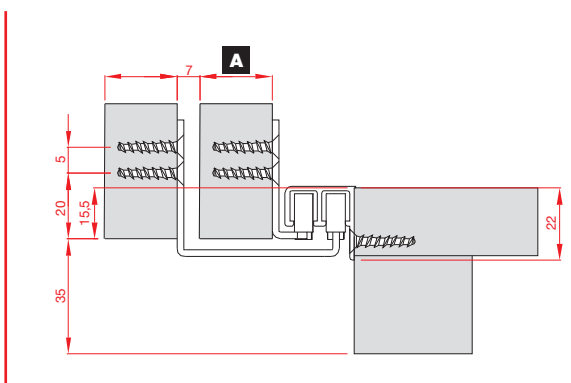
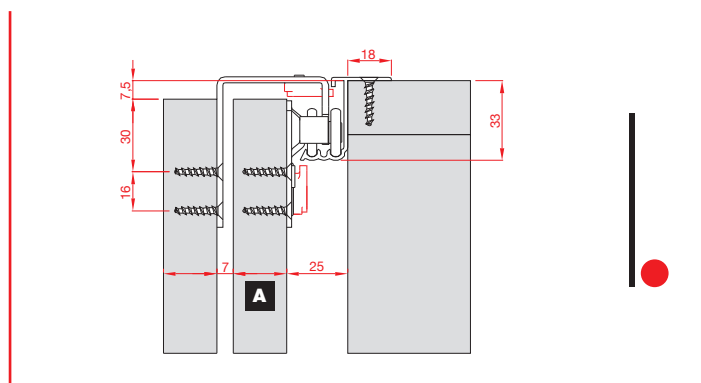

MEASUREMENTS DESCRIPTION / DESCRIZIONE MISURE

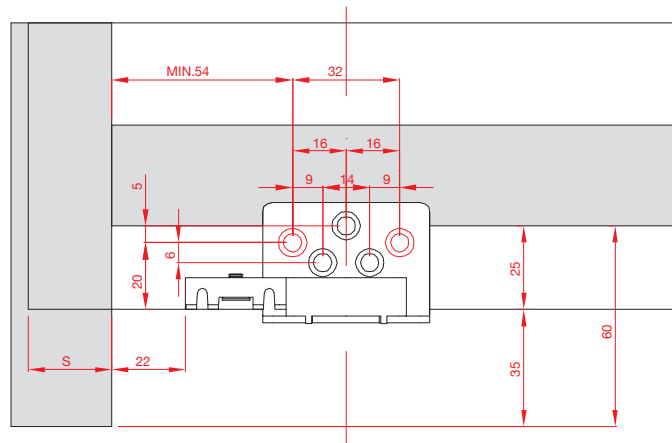
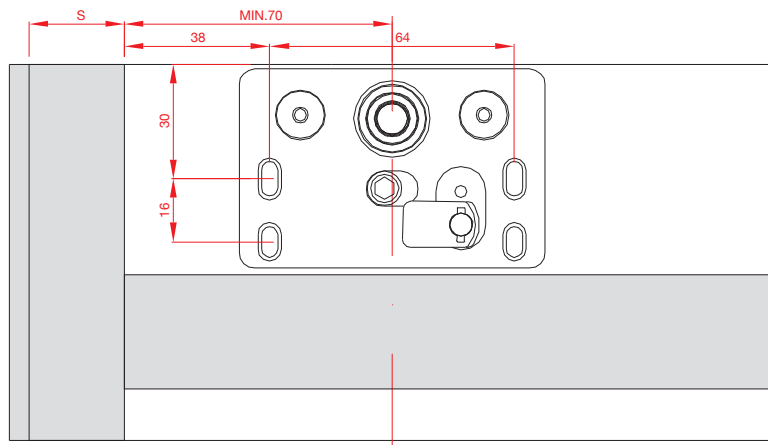

S = OVERLAP SIDE DOOR / S = SORMONTO ANTA SU FIANCO

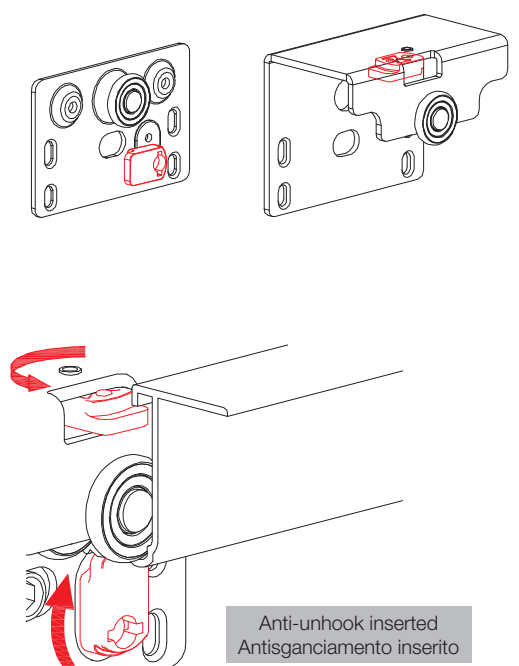
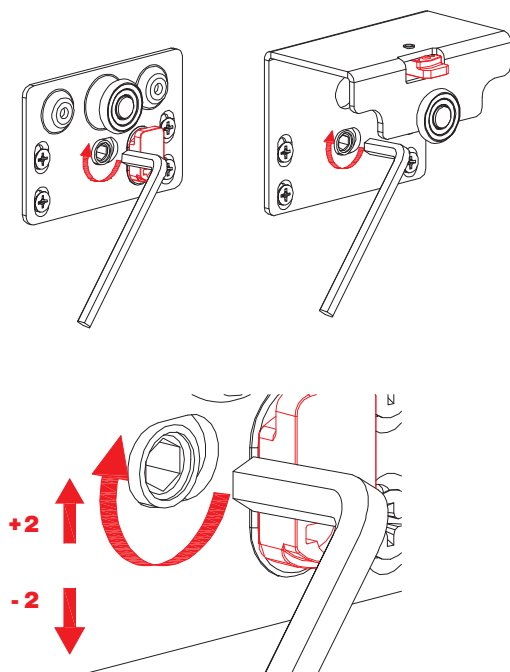

DOOR ADJUSTMENT / REGOLAZIONE ANTA

DOOR HOOKUP POSITION / POSIZIONE DI AGGANCIAMENTO ANTA





Frontalino

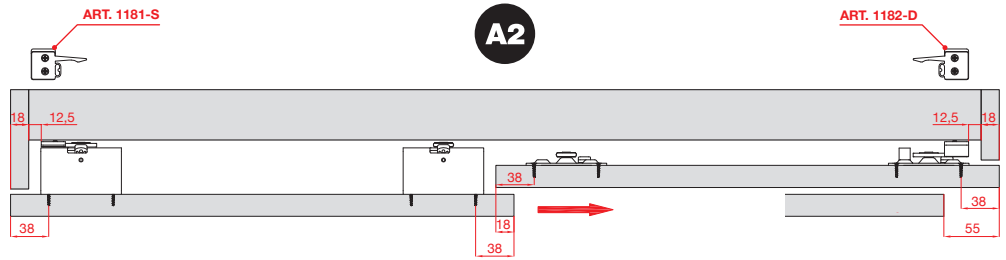

Front facing sliding doors
Ante scorrevoli a posizione frontale

-  N.2 Doors
N.2 Ante
-  External door - Right opening
Anta esterna - Apertura a destra



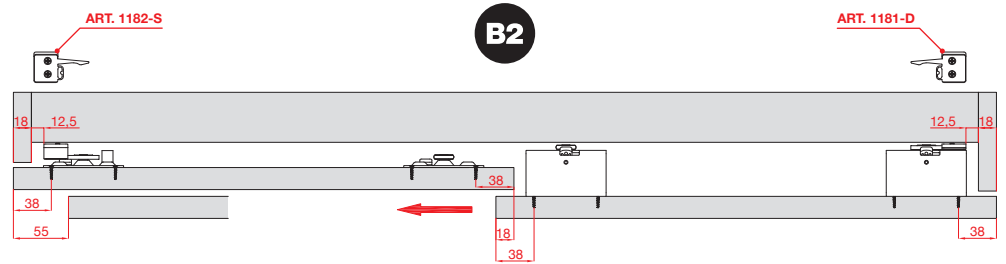

-  N.2 Doors
N.2 Ante
-  External door - Left opening
Anta esterna - Apertura a sinistra



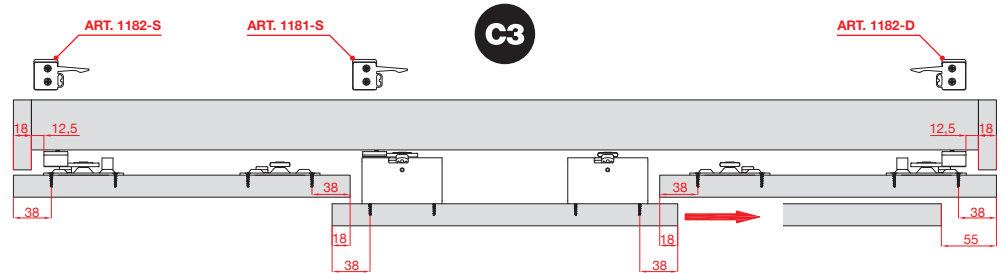

-  N.3 Doors
N.3 Ante
-  External door - Right opening
Anta esterna - Apertura a destra

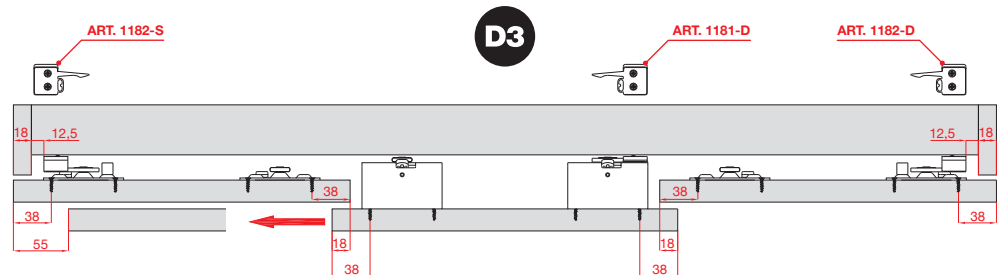

-  N.3 Doors
N.3 Ante
-  External door - Left opening
Anta esterna - Apertura a sinistra



-  N.3 Doors
N.3 Ante
-  External door - Right/Left opening
Anta esterna - Apertura a destra/sinistra

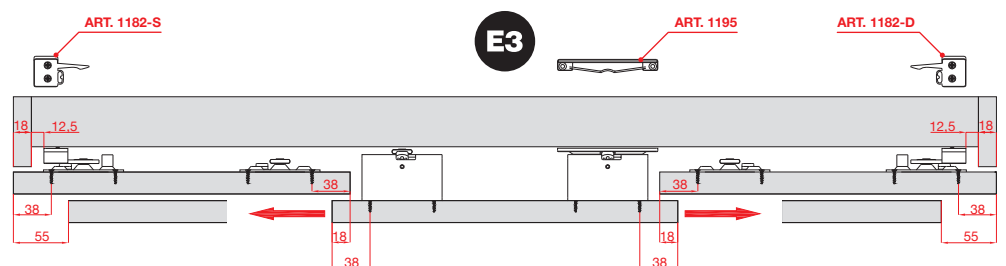



Terno Scorrevoli S.p.A.

**Via Ravenna, 4 - 20814 Varedo (MB) ITALY
Phone +39 0362 543001 - Fax +39 0362 582290**

**terno@ternoscorrevoli.com
www.ternoscorrevoli.com**