

# PROFIL LED CORNER14 EE7F/TY 2000 CZARNY ANOD. /OP

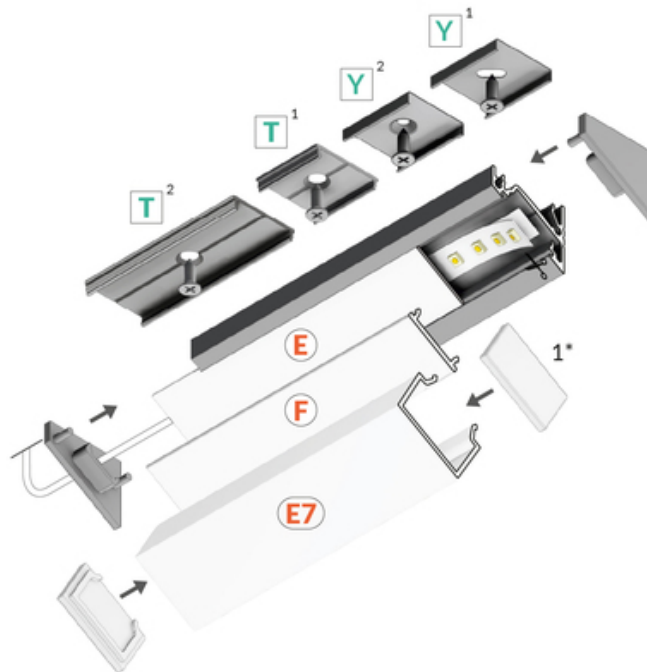

	<ul style="list-style-type: none"> <li>• ukryte mocowanie</li> <li>• dwa kąty świecenia: 30°/60°</li> </ul>	CE Wzory przemysłowe EU Wyprodukowane w Polsce	 Kup produkt
--	---	--	-----------------

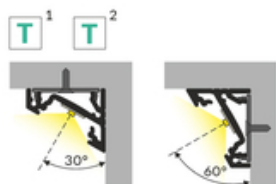
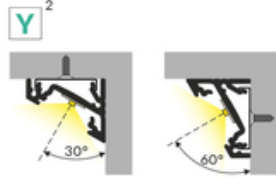
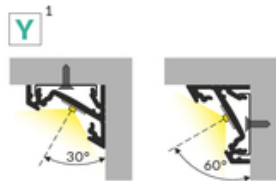
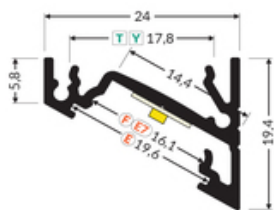

1\*  
end cap E7  
zaślepka E7



## Informacje podstawowe

Indeks: A4020021  
EAN: 5901597203766  
Materiał: aluminium  
Kolor: czarny anodowany  
Długość [mm]: 2000  
Szerokość [mm]: 24  
Wysokość [mm]: 19.4  
Waga [kg]: 0.448  
Waga opakowania [kg]: 0.012  
Producent: TOPMET  
Kraj pochodzenia, wytworzenia: PL

Jednostka miary: szt.  
Typ opakowania jednostkowego: folia POF  
Wymiary opakowania jednostkowego [mm]: 2000 x 24 x 19,4  
Opakowanie zbiorcze [szt]: 30  
Typ opakowania zbiorczego: karton  
Waga produktu z opakowaniem zbiorczym [kg]: 14.5

## DOSTĘPNE KOLORY

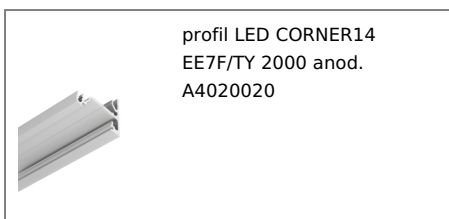

## DOSTĘPNE WARIANTY

1000 mm, 2000 mm, 3000 mm, 4050 mm

## Dopasowane elementy

### KLOSZE DO PROFILI LED

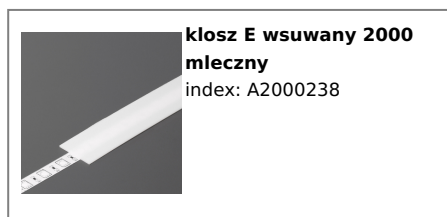

### ZAŚLEPKI DO PROFILI LED

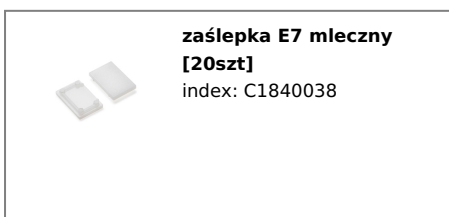

---

## ŁĄCZNIKI DO PROFILI LED



**łącznik CORNER14 90st**  
czarny anod. /op  
index: A4990021



**łącznik T [1szt]**  
index: C6990000

---

## UCHWYTY DO PROFILI LED



**uchwyt Y cone inox**  
[20szt]  
index: A2130019



**uchwyt T [20szt]**  
index: C6960000



**uchwyt Y inox [20szt]**  
index: A2090019