

PROFIL LED SMART16 BC3/U4 2000 ANOD.



Meblowe



max 16 mm



Nawierzchniowe

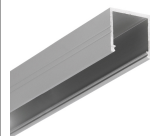

- gniazdo Slick
- prosty montaż klosza
- 2 rowki
- 2 poziomy przymocowania uchwyty (z dystansem od płaszczyzny montażowej lub bez)
- ciągła linia światła (przy zastosowaniu taśmy 120 P/m i klosza mlecznego)



Wzory przemysłowe EU



CE



Wyprodukowane w Polsce



Kup produkt

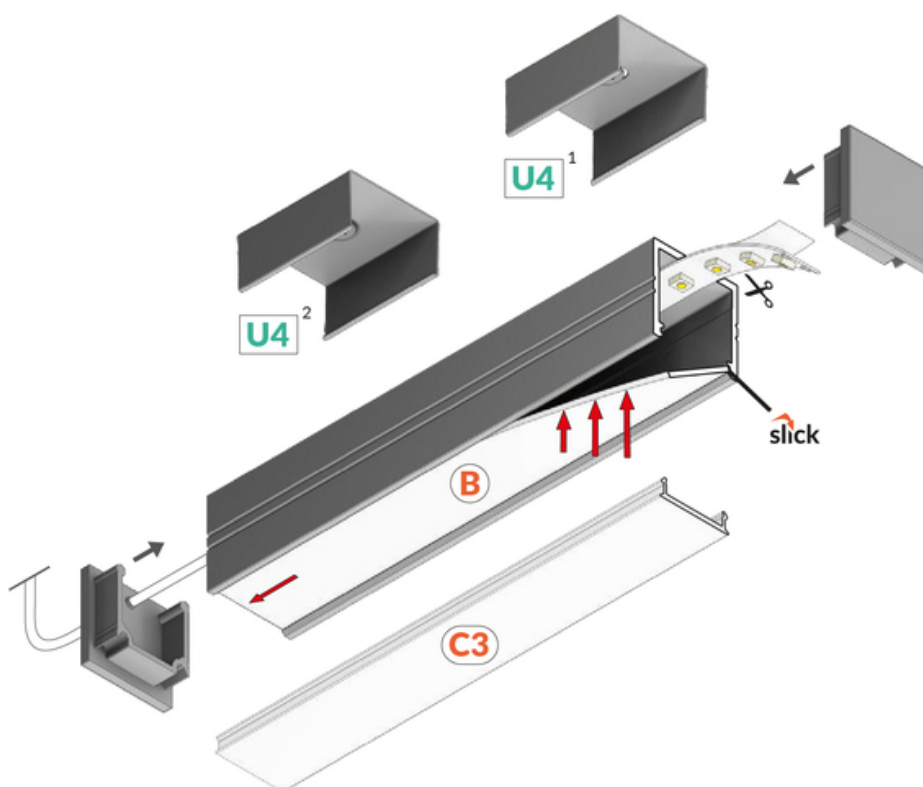
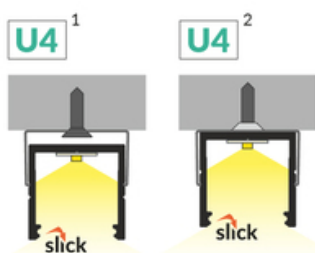
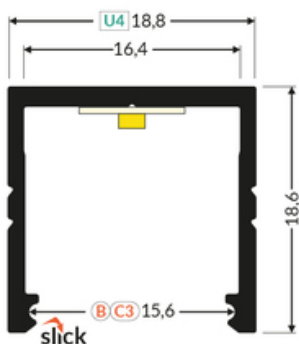

TOPMET LIGHT KŁOSOWICZ WIŚNIEWSKI sp. z o.o.

Ostrowska 354 | 61-312 Poznań | POLAND

tel.: +48 61 872 75 00

info@topmet.pl

data wygenerowania karty pdf: 23.10.2024





Informacje podstawowe

Indeks: F1020020 EAN: 5901597243731 Materiał: aluminium Kolor: anodowany Długość [mm]: 2000 Szerokość [mm]: 18.8 Wysokość [mm]: 18.6 Waga [kg]: 0.402 Waga opakowania [kg]: 0.018 Producent: TOPMET Kraj pochodzenia, wytworzenia: PL	Jednostka miary: szt. Wymiary opakowania jednostkowego [mm]: 2000 x 18,8 x 18,6 Opakowanie zbiorcze [szt]: 40 Typ opakowania zbiorczego: pakiet Waga produktu z opakowaniem zbiorczym [kg]: 16.08
---	---

DOSTĘPNE KOLORY

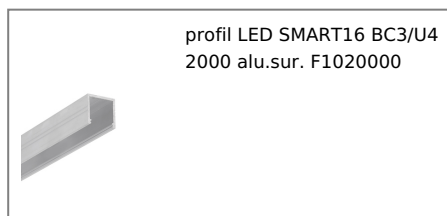
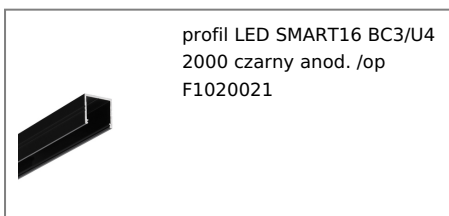

DOSTĘPNE WARIANTY

1000 mm, 2000 mm, 3000 mm, 4050 mm

Dopasowane elementy

KLOSZE DO PROFILI LED

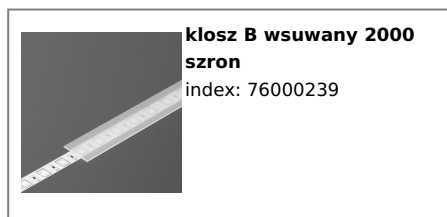
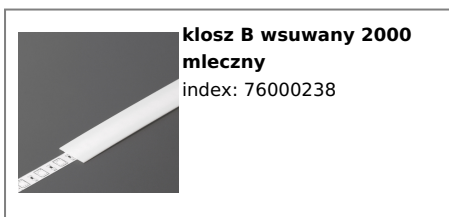

TOPMET LIGHT KŁOSOWICZ WIŚNIEWSKI sp. z o.o.

Ostrowska 354 | 61-312 Poznań | POLAND

tel.: +48 61 872 75 00

info@topmet.pl

data wygenerowania karty pdf: 23.10.2024

ZAŚLEPKI DO PROFILI LED



**zaślepka SMART16-BC3
srebrny [20szt]**
index: F1999940



**zaślepka SMART16-BC3
szary [20szt]**
index: F1999922

UCHWYTY DO PROFILI LED



**uchwyt U4 cone inox
[20szt]**
index: F1980019