

PEN8 I

SURFACE PROFILE / NAWIERZCHNIOWY

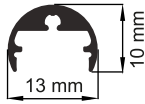

max
8 mm



13 mm

10 mm

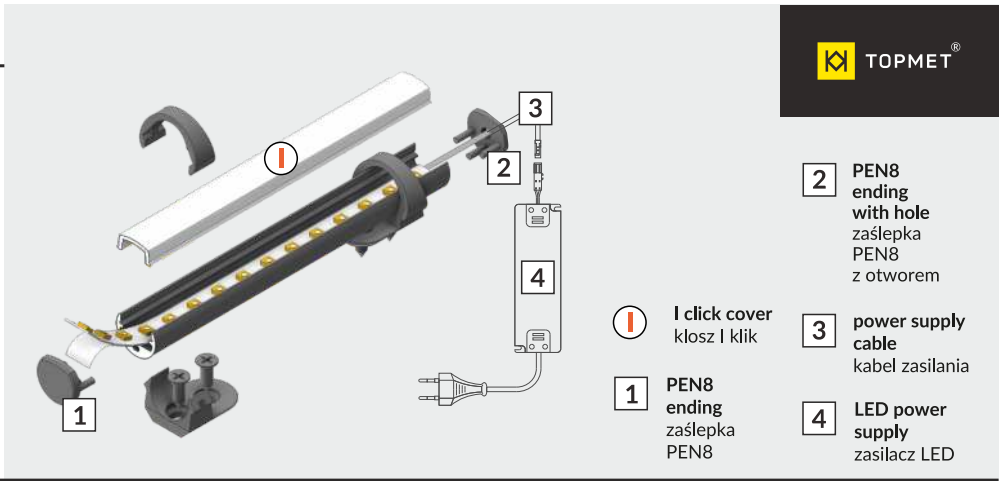
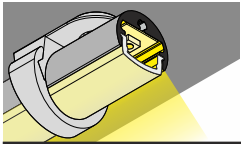

2 PEN8 ending with hole
zaślepka PEN8 z otworem

3 power supply cable
kabel zasilania

4 LED power supply
zasilacz LED

I click cover
klosz I klik

1 PEN8 ending
zaślepka PEN8



scissors
nożyczki



pliers
kombinerki



hacksaw
piła



soldering iron
lutownica



solder
cyna



drill
wiertarka

I

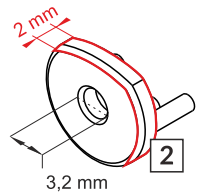
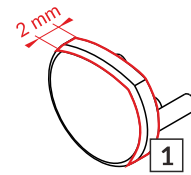
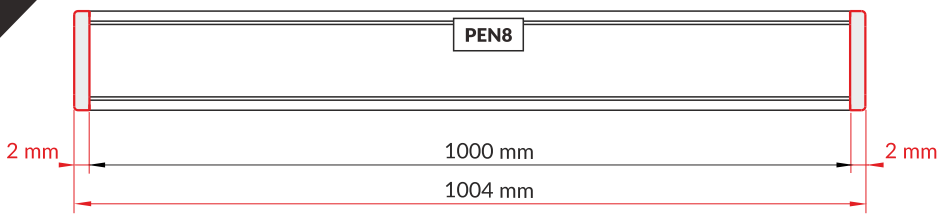

Note! Ending thickness increases the length of the luminaires (+ 2 x 2 mm).
Uwaga! Grubość zaślepki zwiększa długość oprawy (+ 2 x 2 mm).

II

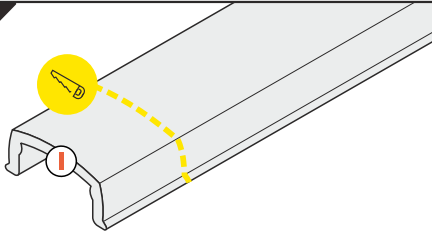

The length of the cover is equal to the length of the profile.

Długość klosza równa jest długości profilu.

III

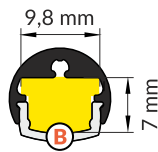
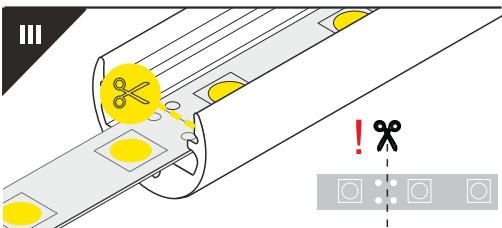

Dimensions of the space to install LED source
Wymiary przestrzeni do zamontowania źródła LED.

IV

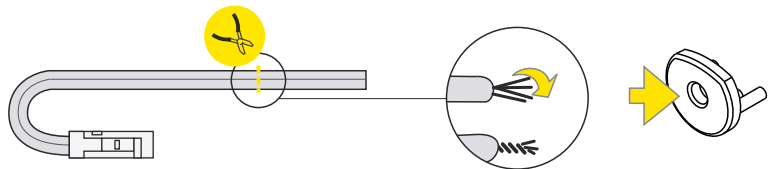
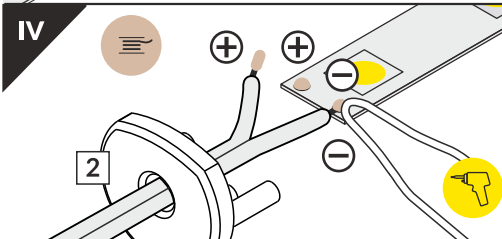

V

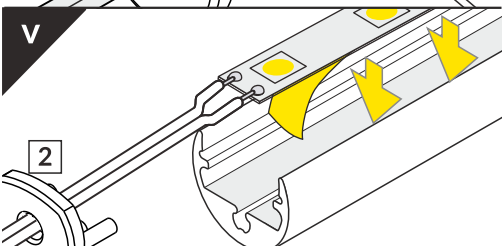

VI

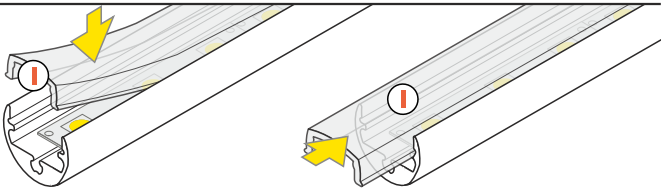

I slide cover / klosz I klik

VII MOUNTING / MONTAŻ

page / str. 2	PEN8 simple holder / uchwyt PEN8 prosty
page / str. 2	PEN8 ring holder / uchwyt PEN8 ring
page / str. 3	PEN8 holder flat / uchwyt PEN8 płaski
page / str. 3	PEN8 stretcher holder / uchwyt PEN8 rozporowy
page / str. 4	PEN8 jointed holder with thread / uchwyt PEN8 przegubowy z gwintem
page / str. 5	PEN8 jointed holder with ceiling / uchwyt PEN8 przegubowy z podsufitką
page / str. 6	PEN8 double holder with threads / uchwyt PEN8 podwójny z gwintem
page / str. 7	PEN8 double holder with ceilings / uchwyt PEN8 podwójny z podsufitką
page / str. 8	PEN8 end holder / uchwyt PEN8 końcowy

PEN8 simple holder / uchwyt PEN8 prosty

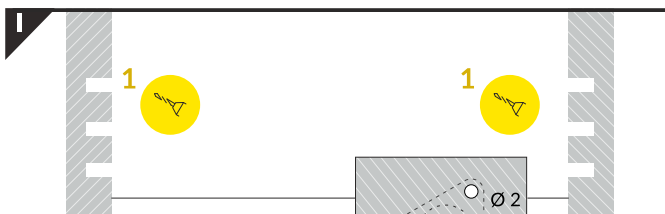

Note! Don't need to drill if you are mounting on a soft material. Just mark the spots for the screws.

Uwaga! Jeżeli montujesz w miękkim materiale, możesz jedynie zaznaczyć punkty na śruby.

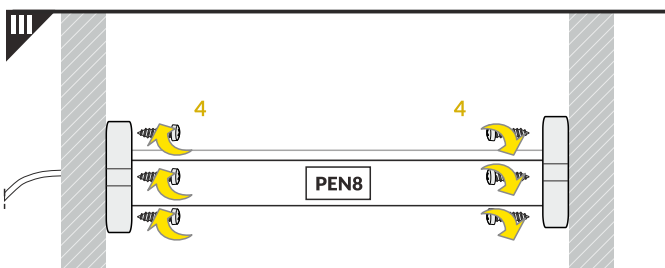
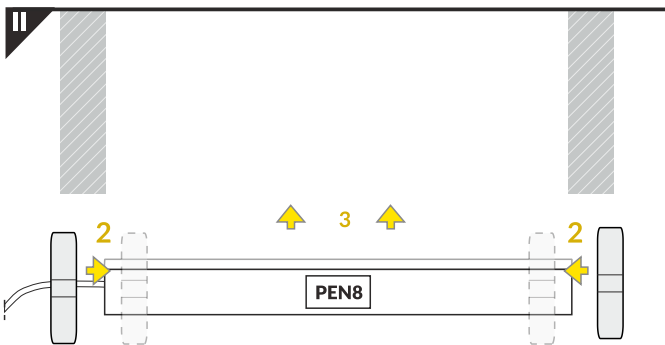

PEN8 ring holder / uchwyt PEN8 ring

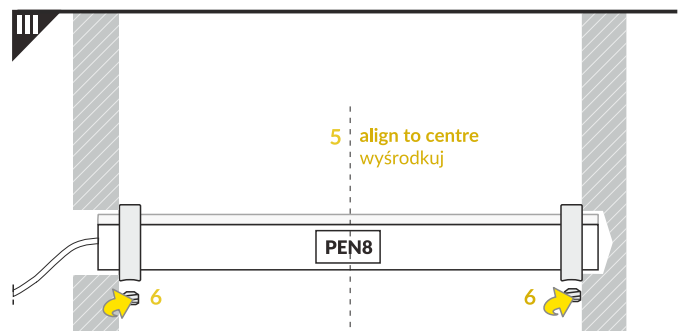
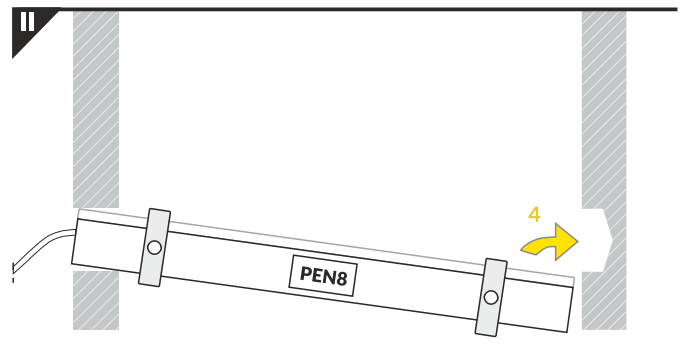
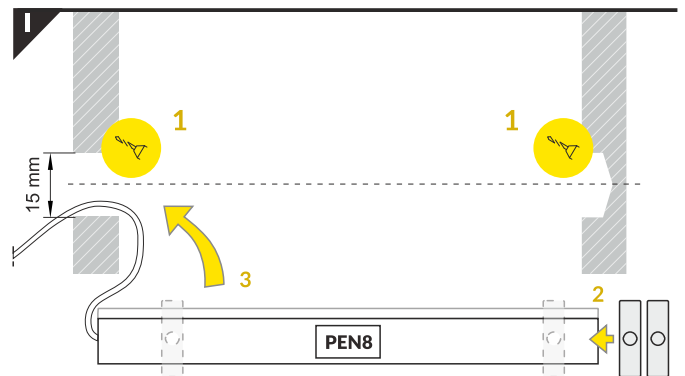

PEN8 holder flat / uchwyt PEN8 płaski

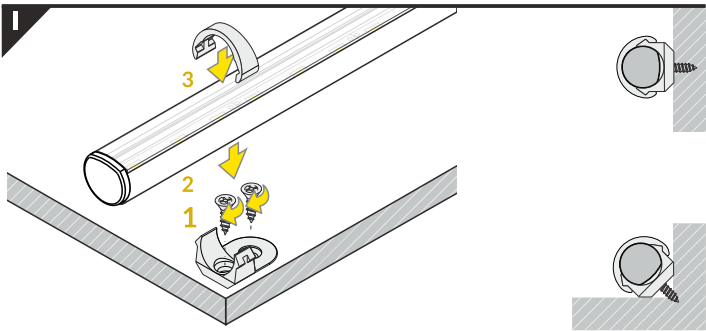

PEN8 stretcher holder / uchwyt PEN8 rozporowy

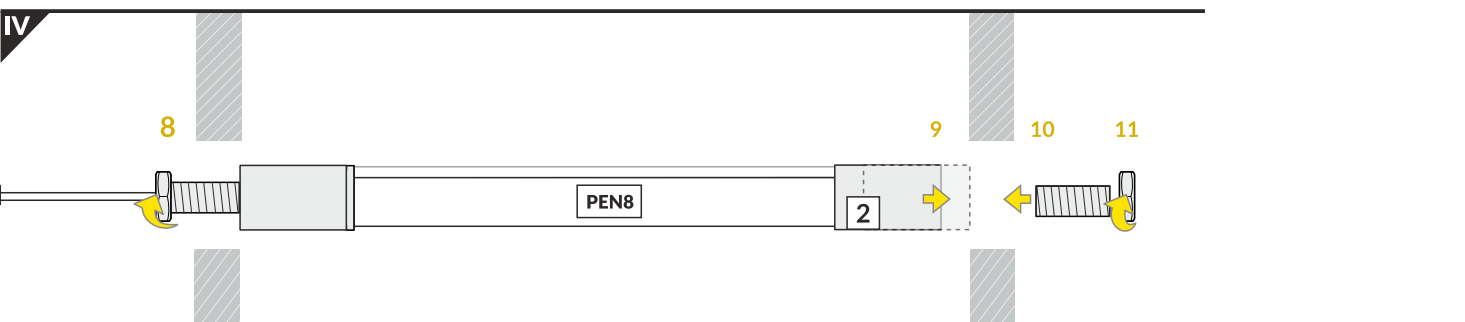
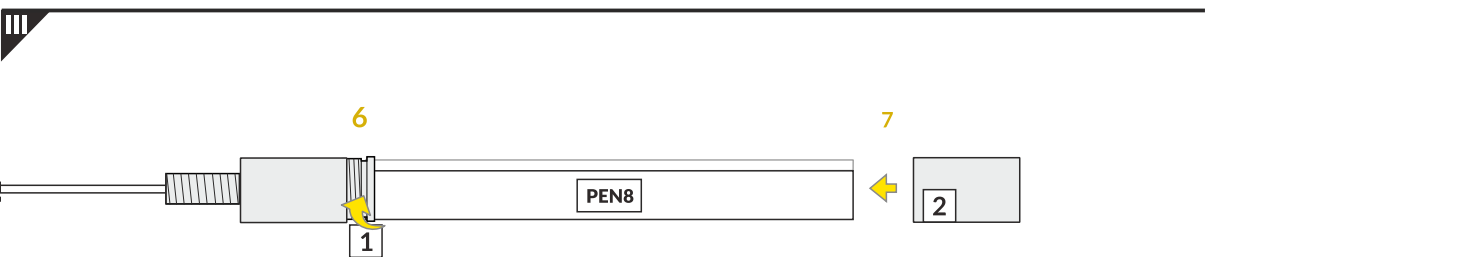
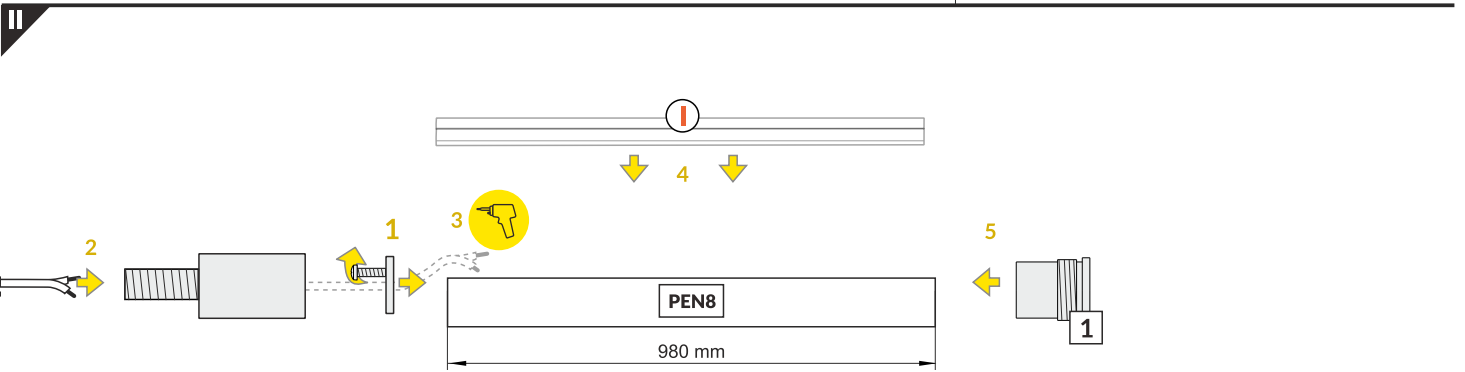
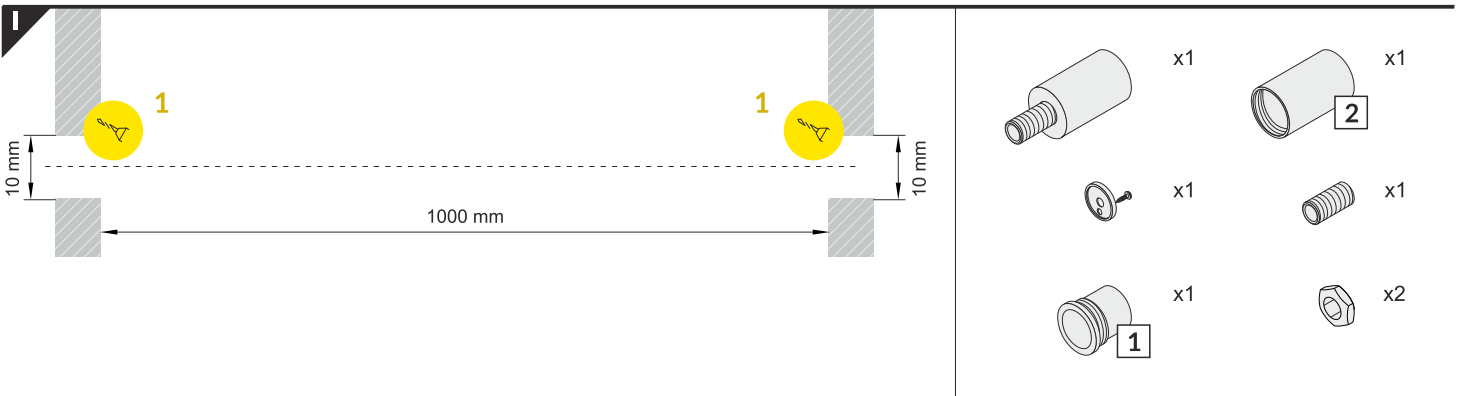

PEN8 jointed holder with thread / uchwyt PEN8 przegubowy z gwintem

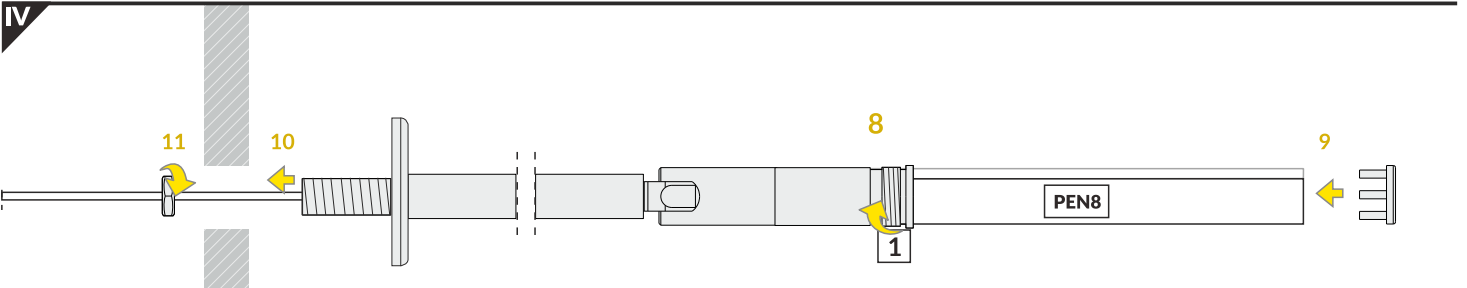
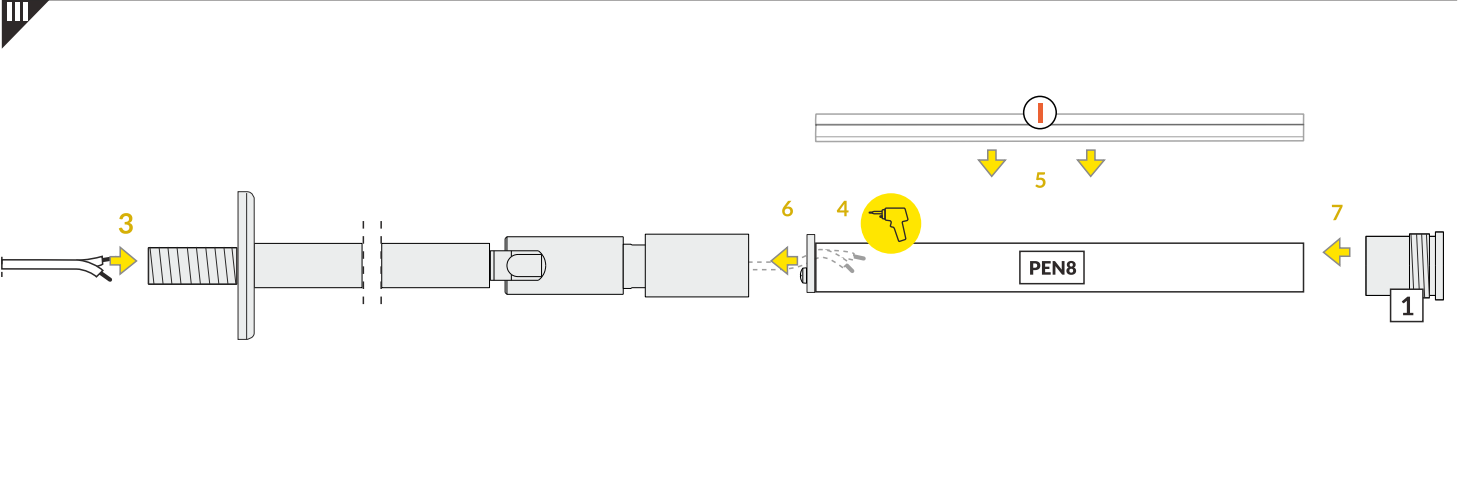
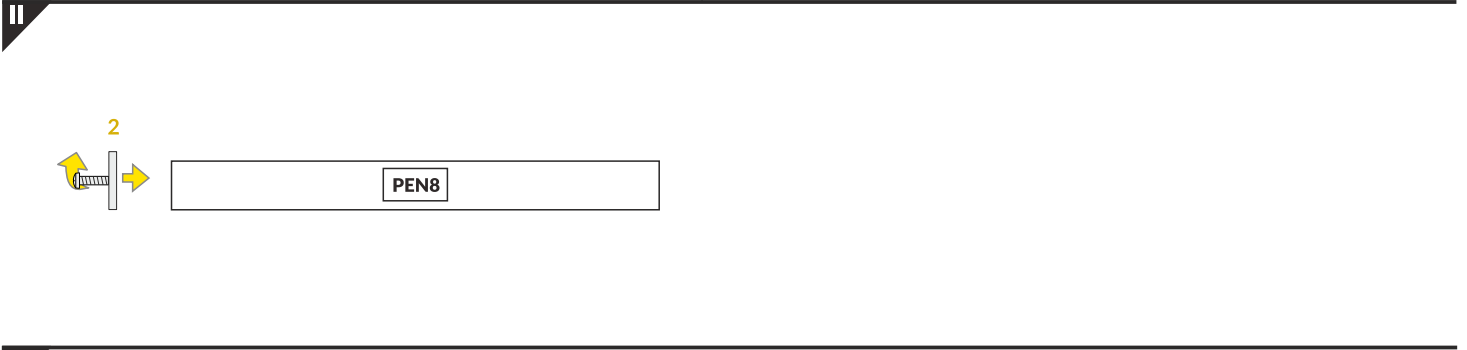
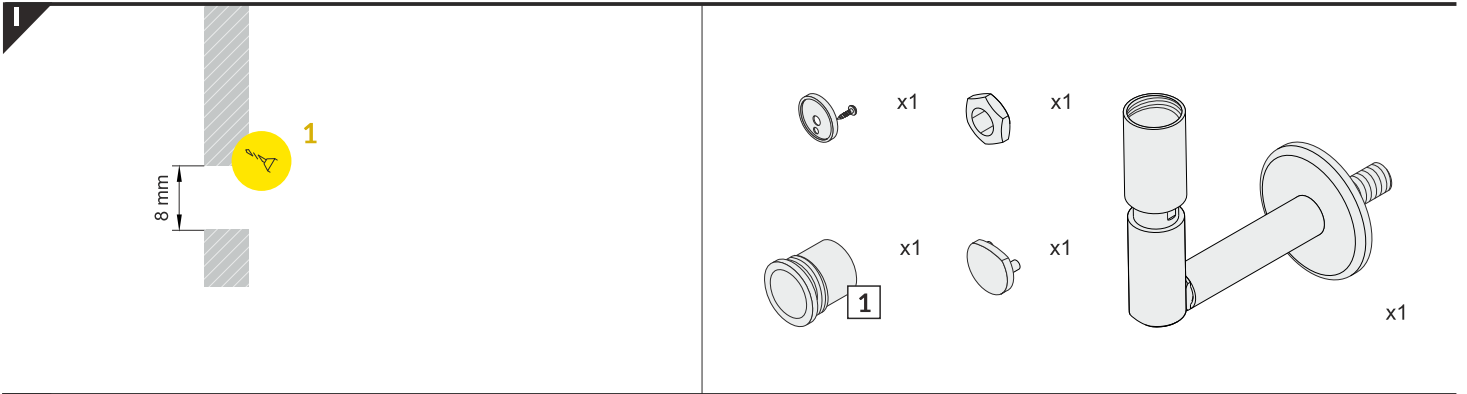

PEN8 jointed holder with ceiling / uchwyt PEN8 przegubowy z podsufitką

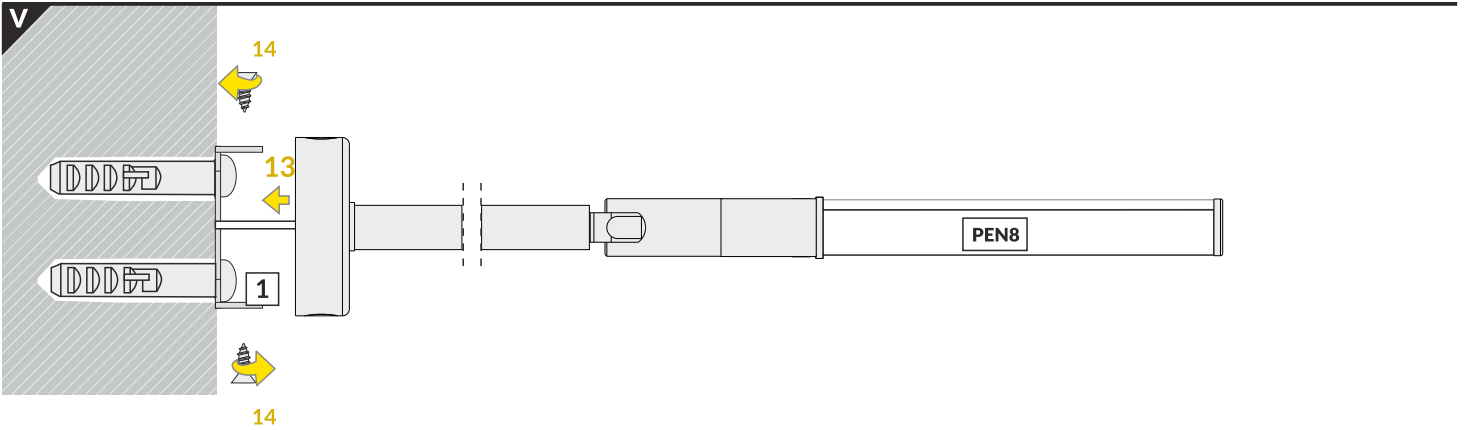
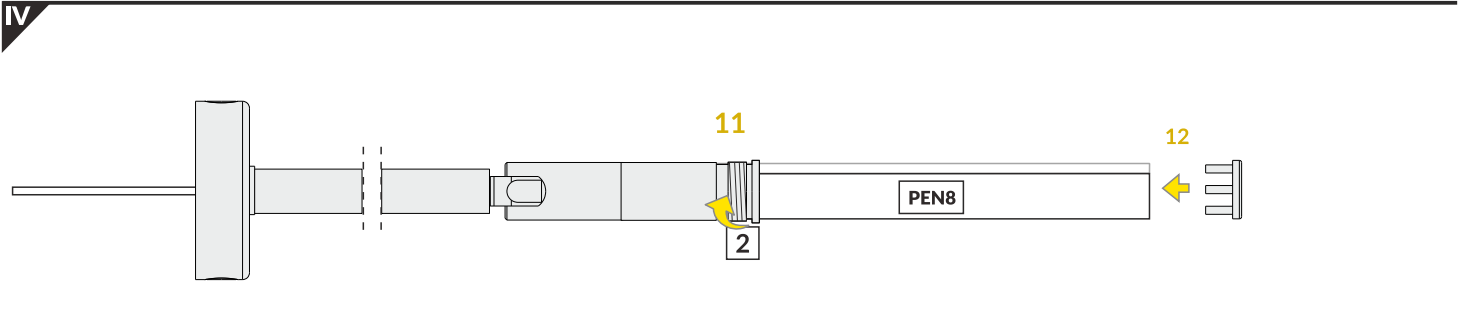
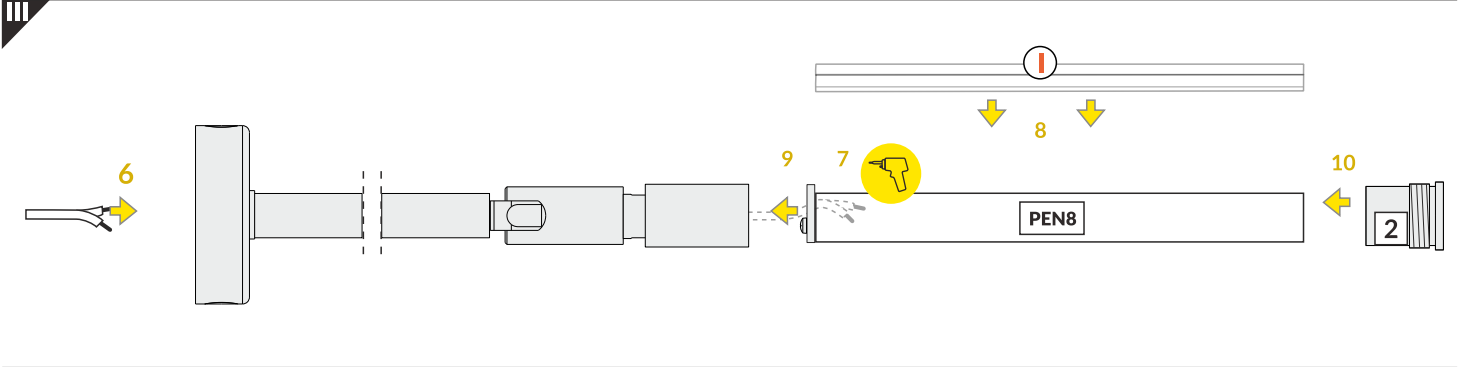
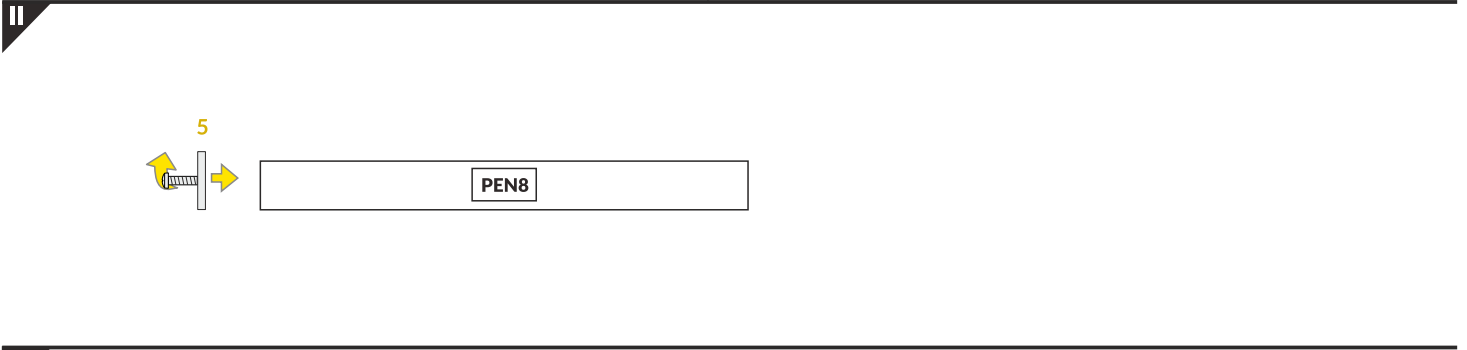
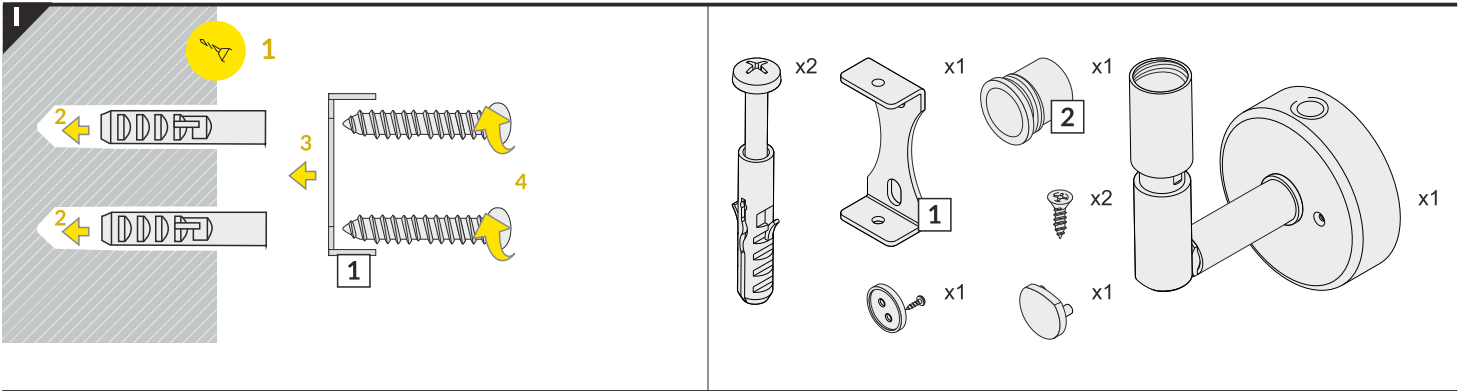

PEN8 double holder with threads / uchwyt PEN8 podwójny z gwintem

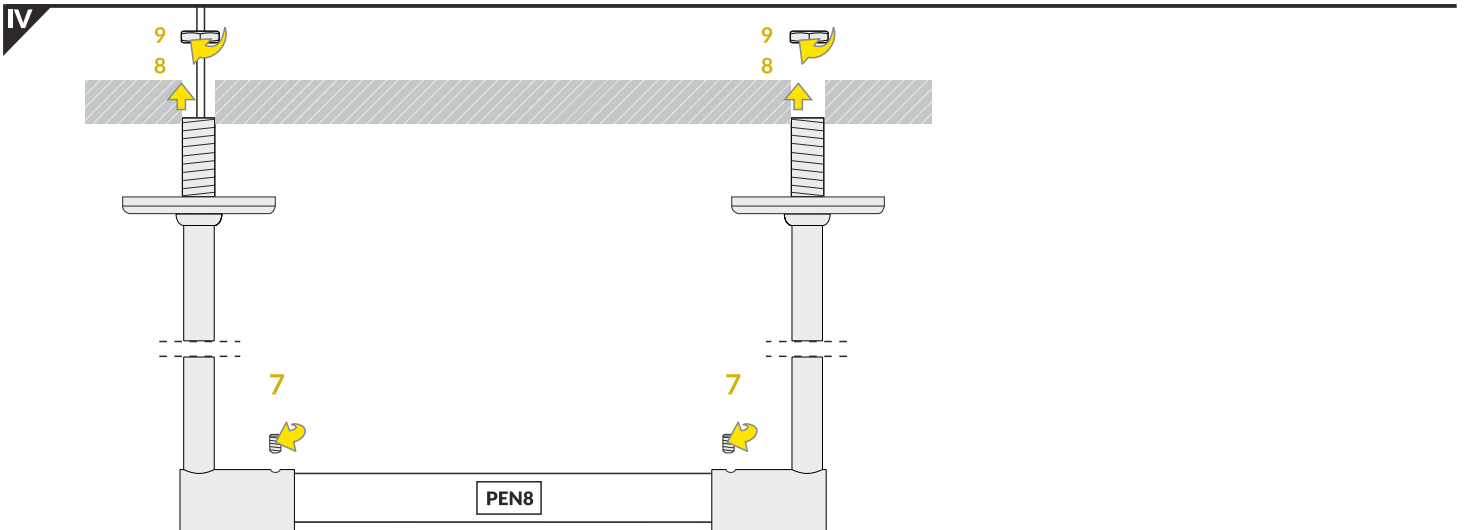
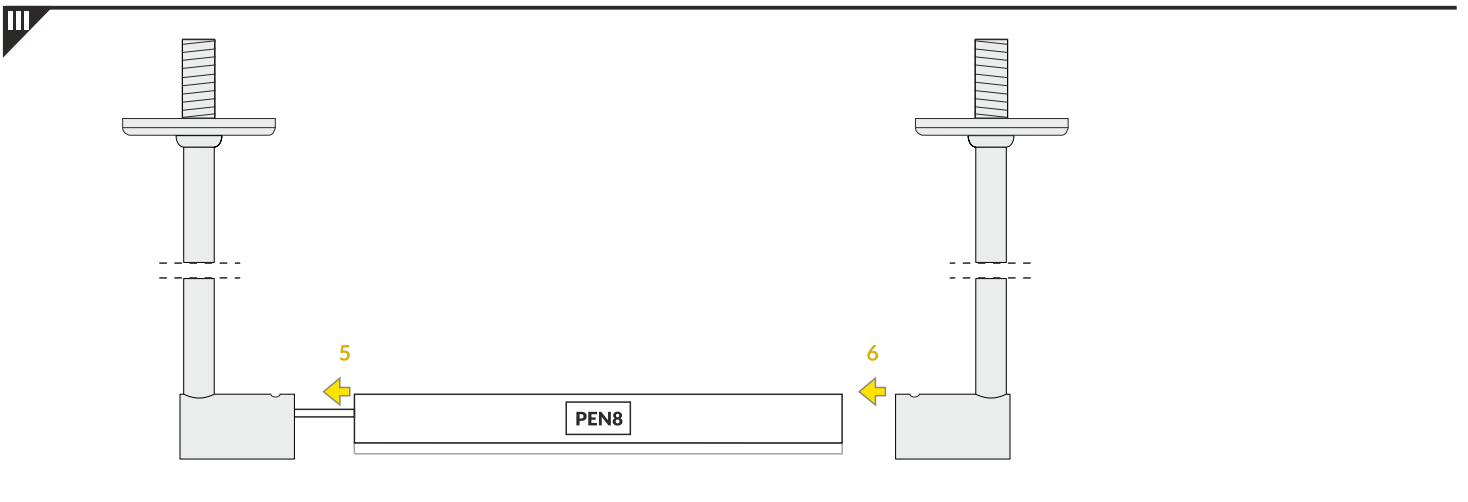
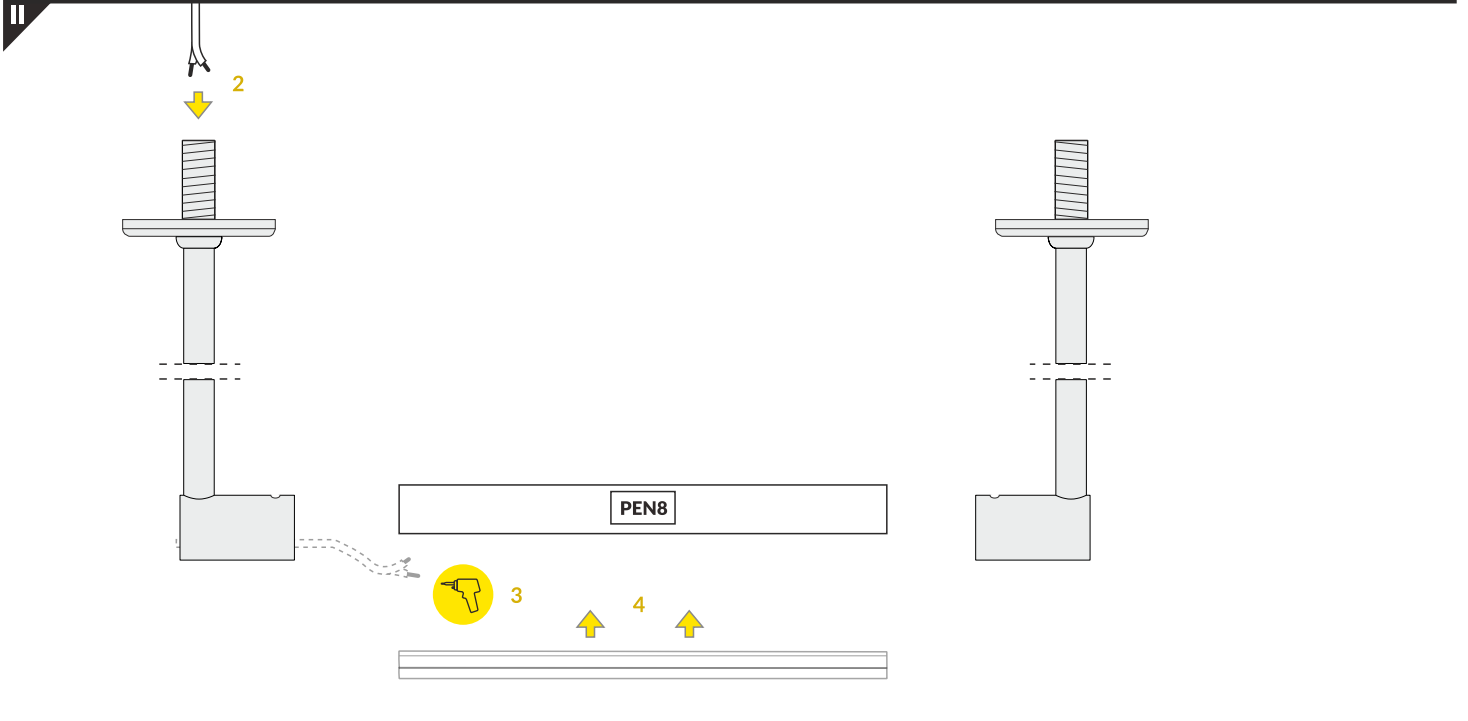
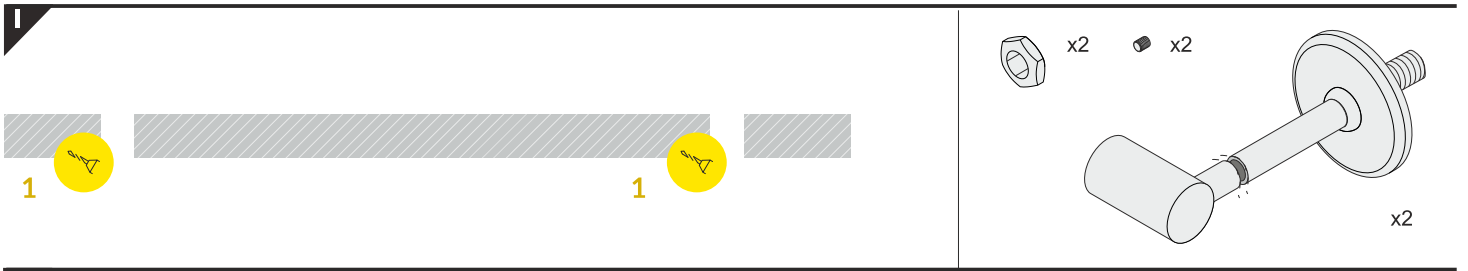

PEN8 double holder with threads / uchwyt PEN8 podwójny z podsufitkami

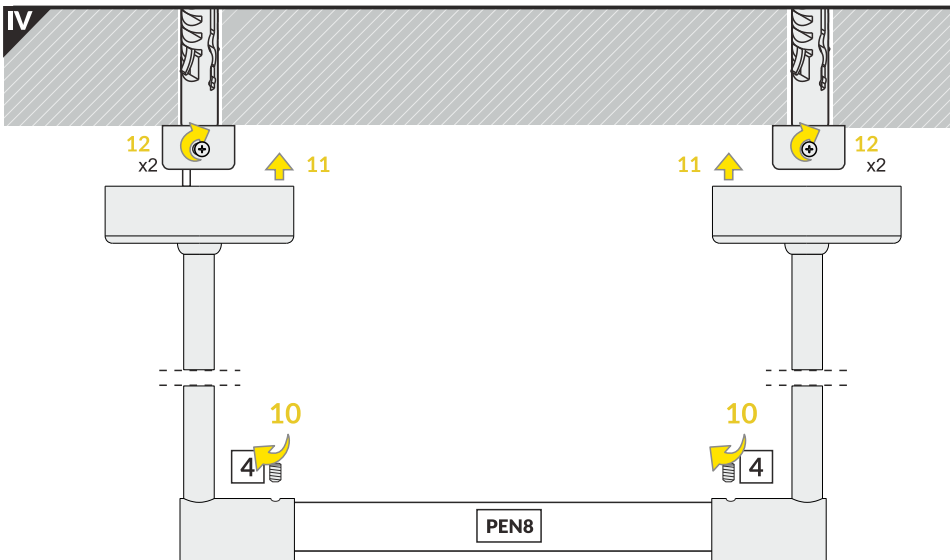
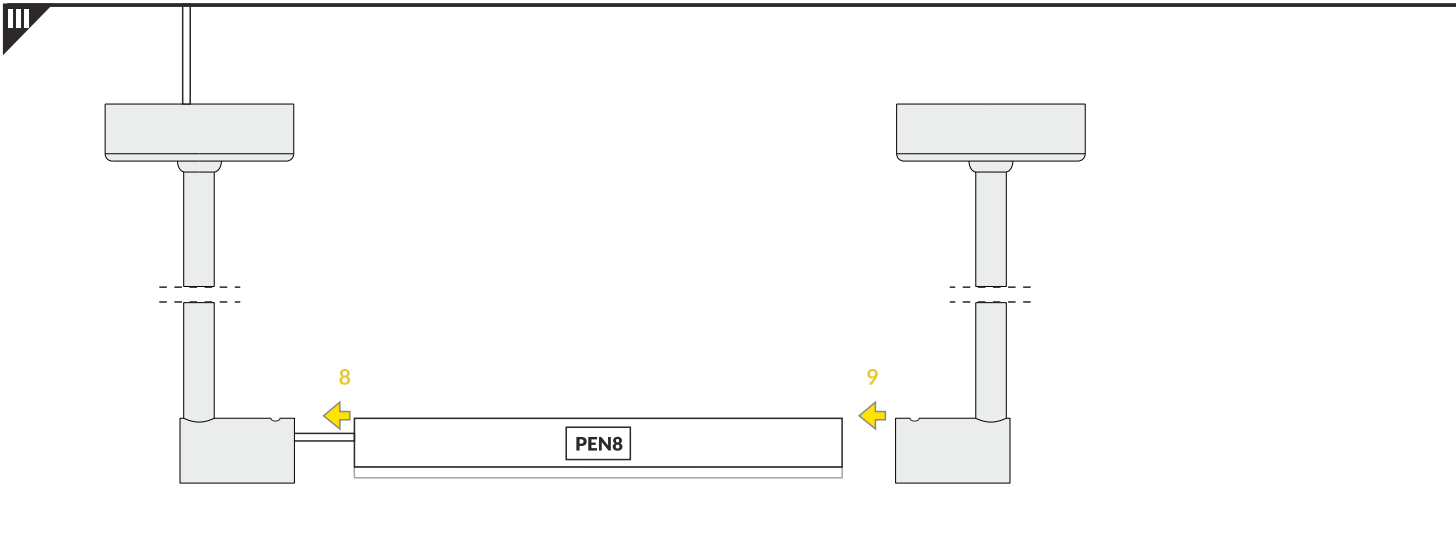
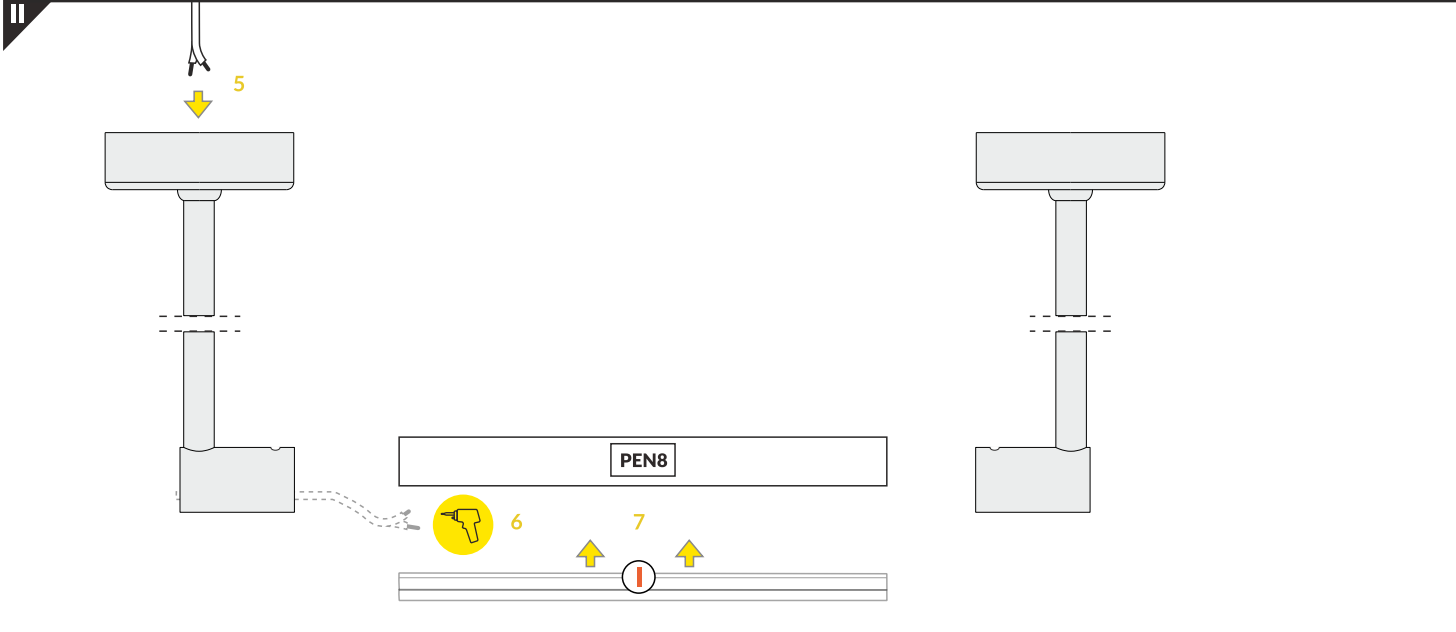
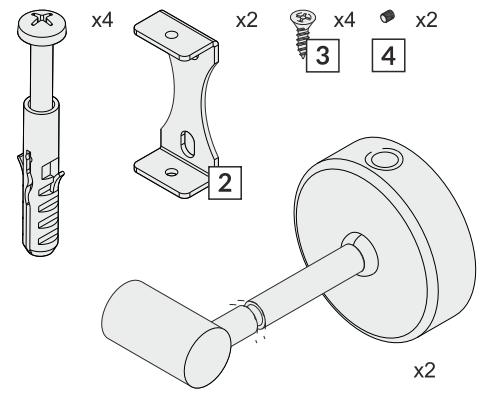
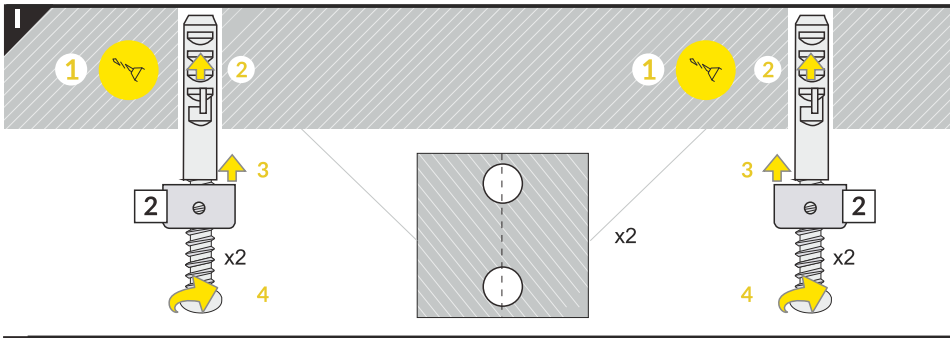

PEN8 end holder / uchwyt PEN8 końcowy

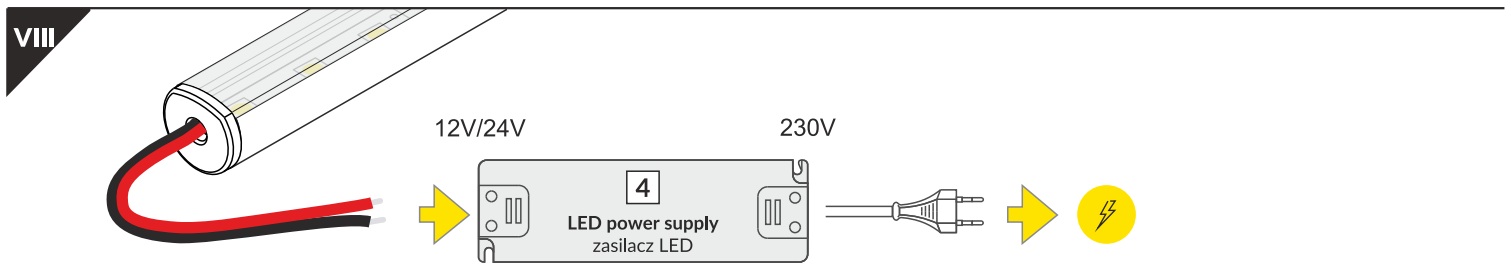
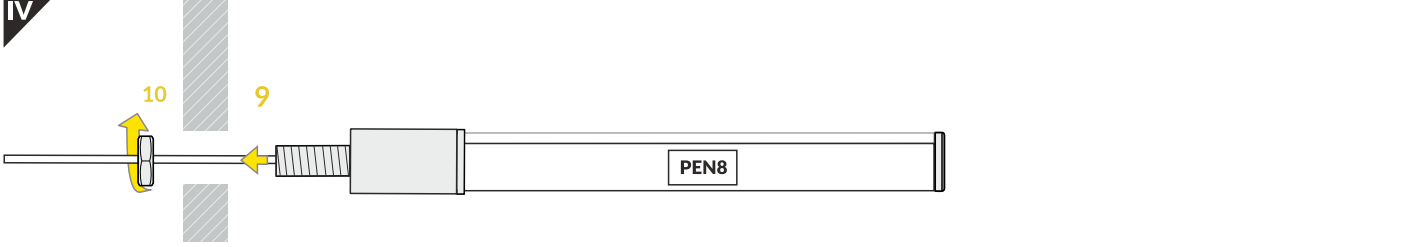
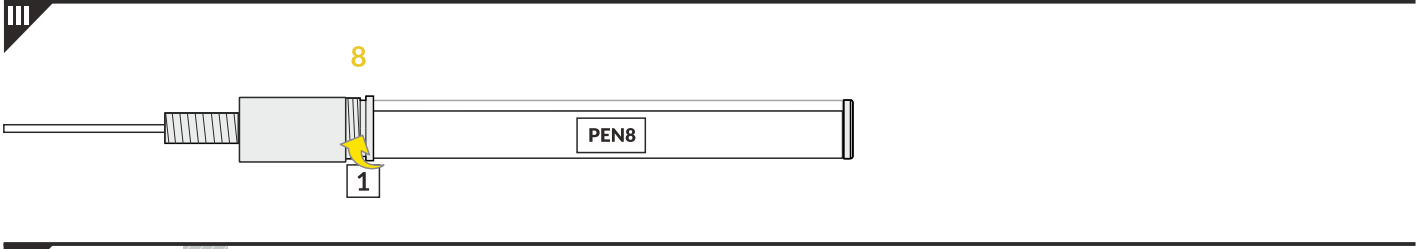
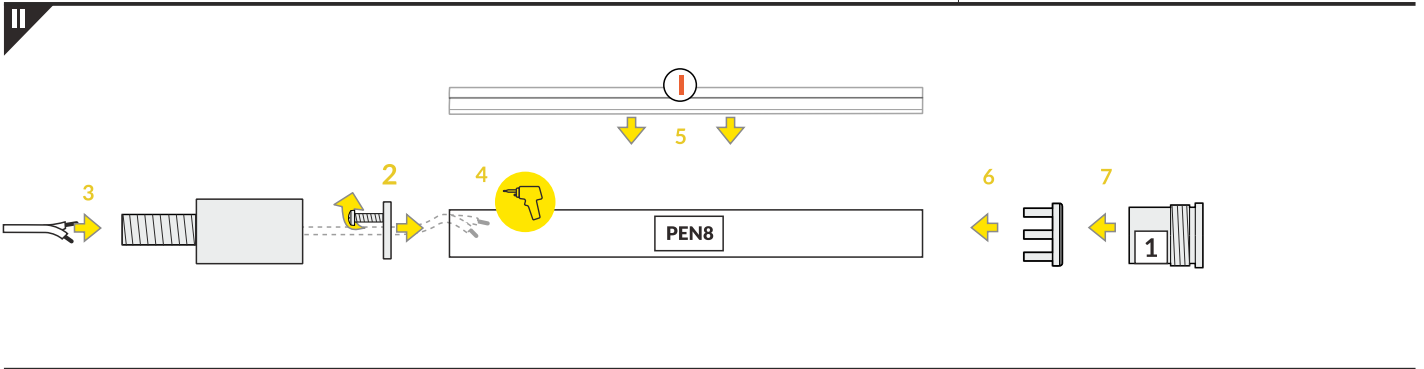

ACCESSORIES / AKCESORIA

- power switches
- controller + remote
- movement sensors
-
- włączniki
- sterownik + pilot
- czujniki ruchu

Check the rest - TOPMET catalogue or www.topmet.co.uk
 Zobacz więcej - katalog TOPMET lub www.topmet.pl

