

PROFIL LED CORNER10 BC/UX 3000 CZARNY ANOD. /OP







Meblowe



max 10 mm



Katowe

	<ul style="list-style-type: none"> • dwa kąty świecenia: 30° i 60° • ukryte mocowanie • szeroki wybór akcesoriów, 7 rodzajów kloszy 	<ul style="list-style-type: none"> •  Wzory przemysłowe EU •  CE •  Wyprodukowane w Polsce 	 <p>Kup produkt</p>
---	--	--	--

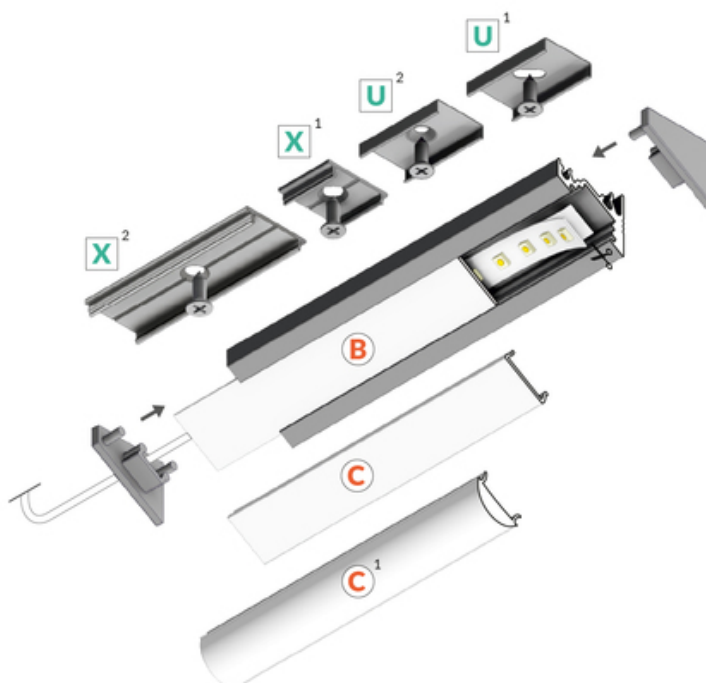
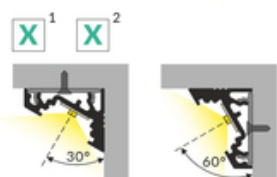
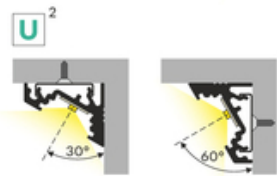
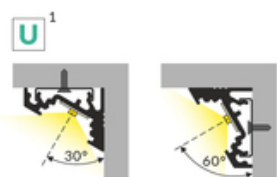
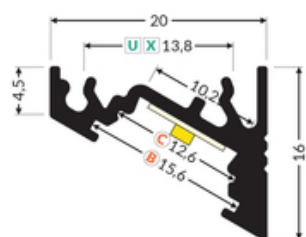

TOPMET LIGHT KŁOSOWICZ WIŚNIEWSKI sp. z o.o.

Ostrowska 354 | 61-312 Poznań | POLAND

tel.: +48 61 872 75 00

info@topmet.pl

data wygenerowania karty pdf: 29.10.2024



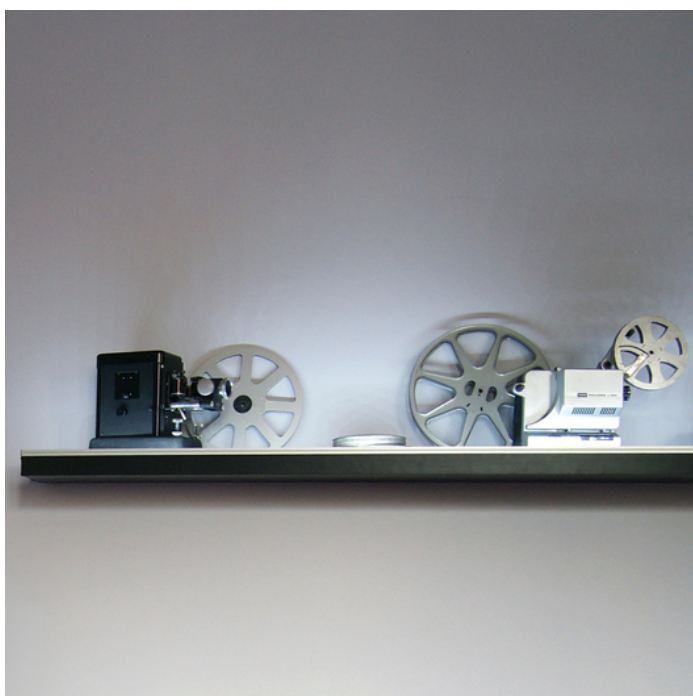

Informacje podstawowe

Indeks: 83170021 EAN: 5901597249412 Materiał: aluminium Kolor: czarny anodowany Długość [mm]: 3000 Szerokość [mm]: 20 Wysokość [mm]: 16 Waga [kg]: 0.6 Waga opakowania [kg]: 0.018 Producent: TOPMET Kraj pochodzenia, wytworzenia: PL	Jednostka miary: szt. Typ opakowania jednostkowego: folia POF Wymiary opakowania jednostkowego [mm]: 3000 x 20 x 16 Opakowanie zbiorcze [szt]: 10 Typ opakowania zbiorczego: pakiet Waga produktu z opakowaniem zbiorczym [kg]: 6
--	--

DOSTĘPNE KOLORY



DOSTĘPNE WARIANTY

1000 mm, 2000 mm, 3000 mm, 4050 mm

Dopasowane elementy

KLOSZE DO PROFILI LED



TOPMET LIGHT KŁOSOWICZ WIŚNIEWSKI sp. z o.o.

Ostrowska 354 | 61-312 Poznań | POLAND

tel.: +48 61 872 75 00

info@topmet.pl

data wygenerowania karty pdf: 29.10.2024

ZAŚLEPKI DO PROFILI LED



**(EOL) zaślepka
CORNER10 czarny
[20szt]**
index: 83150002



**zaślepka CORNER10
gen2 czarny [20szt]**
index: 83990002



**zaślepka CORNER10
gen2 z otworem czarny
[20szt]**
index: 83980002

ŁĄCZNIKI DO PROFILI LED



**łącznik CORNER10 90st
czarny anod. /op**
index: 83110021



łącznik X 180st [1szt]
index: 76350000

UCHWYTY DO PROFILI LED



**uchwyt U cone inox
[20szt]**
index: 76620000



uchwyt U inox [20szt]
index: 76380000

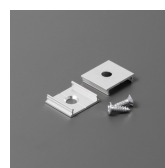

uchwyt X [20szt]
index: 76260000