

FLIPPER

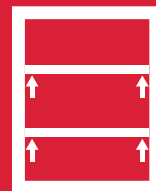

SHELF
SUPPORTS



SYMBOLS AND FINISHES LEGEND

SYMBOLS

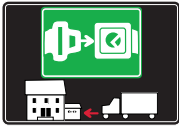

= SHELF SAFELY LOCKED DURING TRANSPORTATION AND AT HOME.



= ANTI-TURNOVER LOCKING SYSTEM



= NORMS / PATENTS



= PHILLIPS / POZIDRIV



= NEWTON



= PART.NO



= HEXAGONAL SOCKET



= FRICTION



= PCS. PER PACKAGE



= BLADE SLOT



= AUTOMATIC



= COMBI SLOT



= DROP DOWN



= CAPACITY LOADING



= COUNTERSUNK HEAD



= WOOD / GLASS THICKNESS



= PAN HEAD



= STANDARD HINGE



= HOLE DIAMETER



= FLANGE HEAD



= KIMANA HINGE



= DIAMETER



= FLAT HEAD



= FLAP HINGE



= LENGTH



= TRILOBULAR SCREW



= WITH SPRING



= HEIGHT



= SELF-TAPPING SCREW



= WITHOUT SPRING



= RIGHT VERSION



= EURO THREAD



= REVERSED SPRING



= LEFT VERSION



= METRIC THREAD



= SETTING CODE



= PRE-INSERTED SCREW



= FOR ROUND TUBE



= PCS. PER PAD



= PRE-INSERTED SCREW AND SPREADING BUSH



= FOR OVAL TUBE



= CUT ON REQUEST



= WITH BUFFER



= SELF ADHESIVE



= WITH MAGNET



= WITH FLANGE

NOTE: Printing errors and omissions may exist despite our best efforts to ensure accuracy. We reserve the right to alter specifications without notice.

MATERIALS

ZA = Zinc Alloy

ST = Steel

HSS = High Speed Steel

BR = Brass

ABS = Acrylonitrile Butadiene Styrene

ZAnk = Nickel-plated Zinc Alloy

STzk = Zinc-plated Steel

AL = Aluminium

WD = Wood

EVA = Ethylene Vinyl Acetate

EP = **ENGINEERING PLASTIC**

+ **EP** = other engineering plastic available on request

SR = **SOFT RUBBER**

+ **SR** = other soft rubber available on request

EPn = Natural Engineering Plastic

EPc = Clear Engineering Plastic

SRn = Natural Soft Rubber

EPw = White Engineering Plastic

EPg = Grey Engineering Plastic

SRw = White Soft Rubber

EPwg = Water Green Engineering Plastic

SRb = Black Soft Rubber



FINISHES



= OTHER FINISHES AVAILABLE ON REQUEST

PART. NO	FINISHES	PART. NO	FINISHES	PART. NO	FINISHES
AA	Natural	JB	Bright Aluminium	QB	Walnut
AB	White	JC	Aluminium - Chrome	RO	Red
AC	Opal White	JD	Matt Aluminium	UZ	T -Met
AE	White 9010	JE	Satin-finished Aluminium	WA	Bronzed
AK	Champagne	JF	Aluminium - Brass	WI	Burnished
AL	Ivory	JG	Aluminium 5	XD	Satin-finished Steel
EA	Black	JL	Aluminium PE 11	YA	Nickel-plated
EB	Glossy Black	JM	Aluminium RAL 9006	YB	Bright Nickel-plated
EC	Matt Black	KA	Chrome	YC	Matt Nickel-plated
EE	Anthracite	KB	Bright Chrome	YD	Satin-finished Nickel-plated
FU	Gunmetal	KC	Matt Chrome	ZA	Zinc alloy
GR	Raw	MA	Brown	ZN	Zinc-plated
HA	Brass-Plated	MB	Light Brown 1	ZQ	Bright Gold
HH	Tropicalized	NN	Metallic Beige	ZY	Titanium
HL	Raw Brass	NO	Beige	ZZ	Clear
IA	Grey	OA	Oak	00	Insignificant finish
IB	Metallic Grey	OZ	Ash		
IF	Middle Grey	PA	Light Ash		
IJ	Light Grey	PZ	Beech		
IL	Grey 20	QA	Maple		



FLIPPER

FLIPPER is the wood shelf support slotted into the shelf by making face borings. The shelf has to be pushed downwards onto the side dowels, which can be placed or screwed into any position required.

The side dowels slot into the socket of the shelf supports and a click locks the shelf in position.

To provide a structural fastening to the furniture screwed side dowels are required, so that the shelf flushes with the sides, due to the angled shape of the shelf support sockets.

In accordance with the regulation: UNI EN 14749/05.

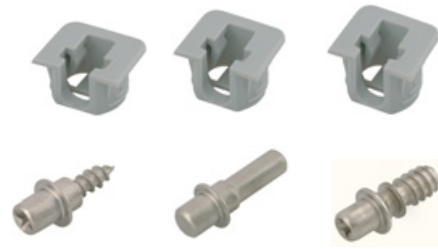

12 mm min.

UNI EN 14749/05

INSTALLATION

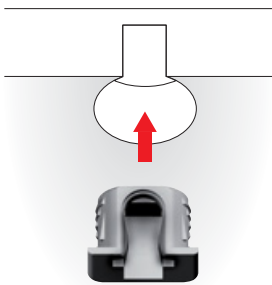

Assembling with smooth pin

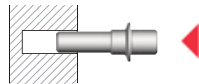

Assembling with threaded pin to achieve horizontal connection

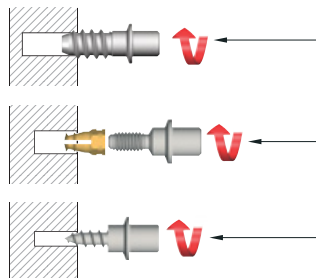

cross PZ2 screwdriver

SHELF INSTALLATION

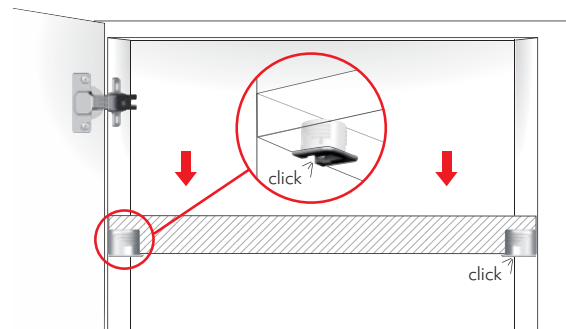
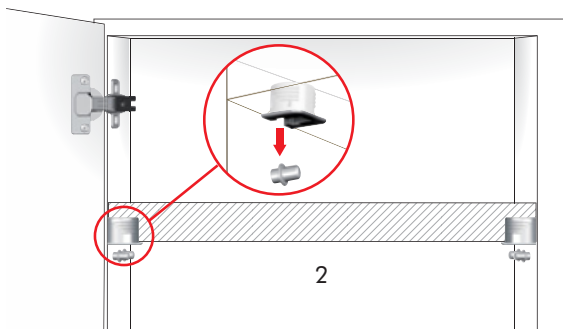
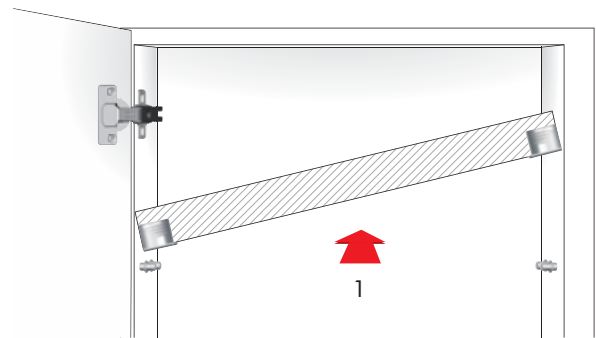

SHELF REMOVAL FOR NEW REPOSITIONING

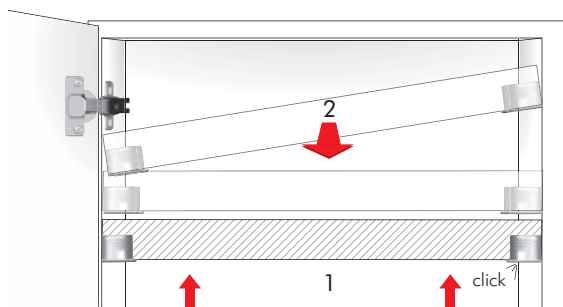

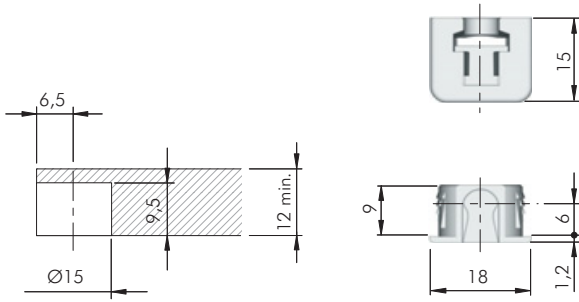

 = 12 mm



EP

 = 10.000 pcs.



10601010AB

10601010JG

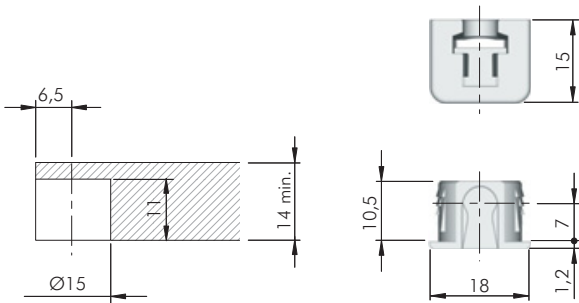

 = 14 mm



EP

 = 10.000 pcs.



10601020AB

10601020JG

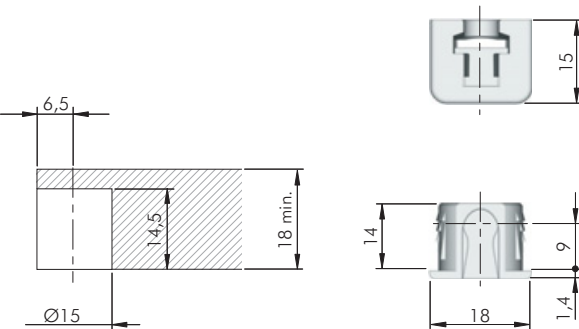

 = 18 mm



EP

 = 8000 pcs.



10601030AB

10601030JG

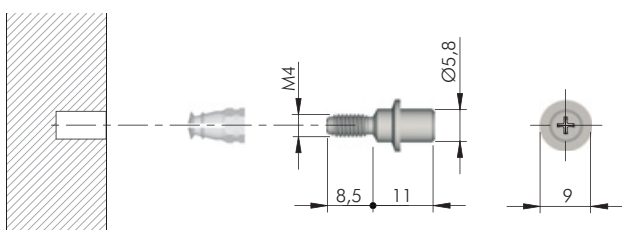

 = M4

 = PZ2

ST

 = 5000 pcs.



10602010ZN

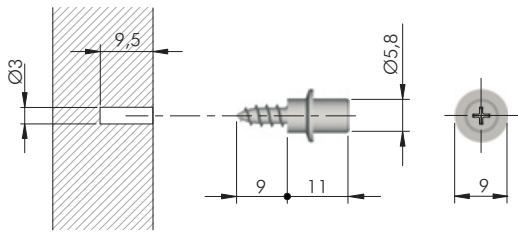
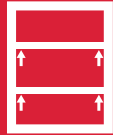

= Ø 3 mm

= PZ2

ST

= 6000 pcs.



10603010ZN

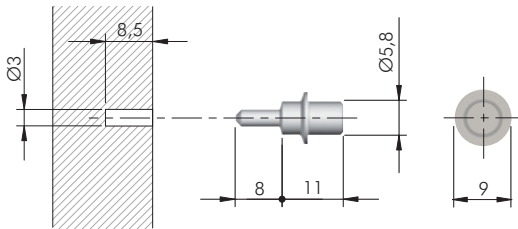

= Ø 3 mm

ST

= 5000 pcs.



10605030ZN

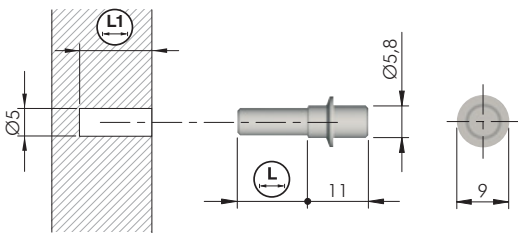

= Ø 5 mm

ST



10605020ZN



12,5



13



3500

10605010ZN

8,5

9

3000

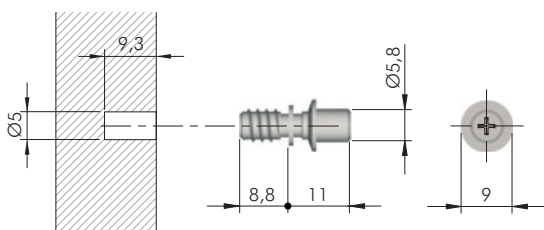

= Ø 5 mm

= PZ2

ST

= 2500 pcs.



10604010ZN

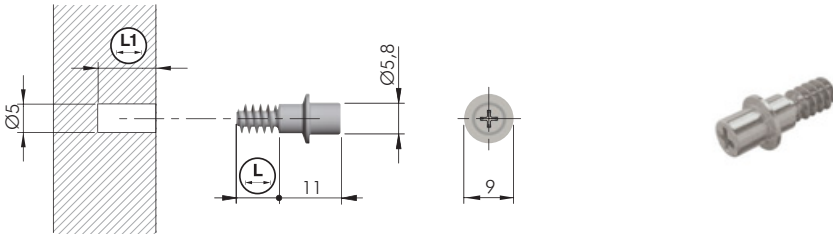

Note: Special threaded pin to avoid hole damging for shelf repositioning.

= Ø 5 mm		
= PZ2		
ST	= 2500 pcs.	
10606020Z	7,7	8,2
10606010Z	9,7	10,2

FLIPPER FIXING ACCESSORY

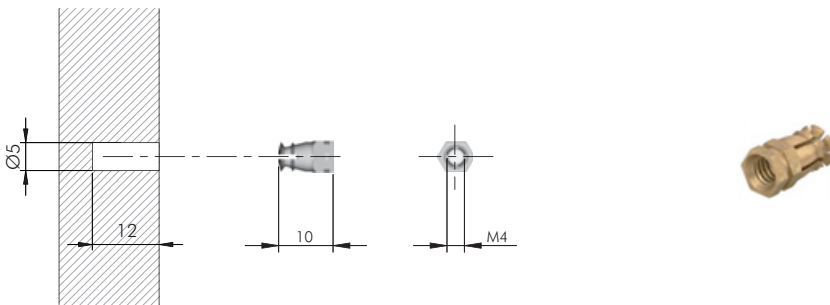

= Ø 5 mm		
= M4		
BR	= 20.000 pcs.	
20502021H		

DRILL BIT FOR FLIPPER 12, 14, 18 mm

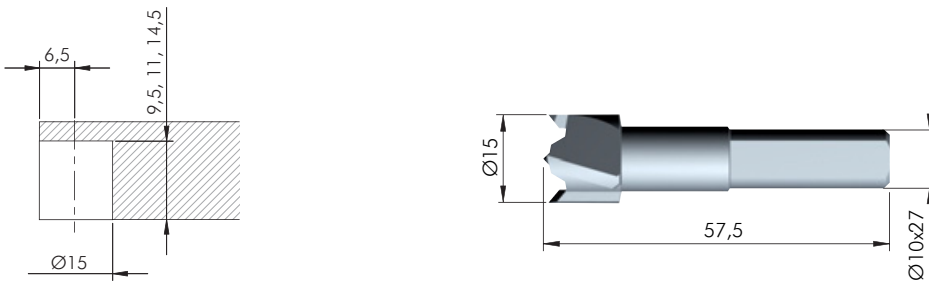

HSS	= on request	
1065201000		

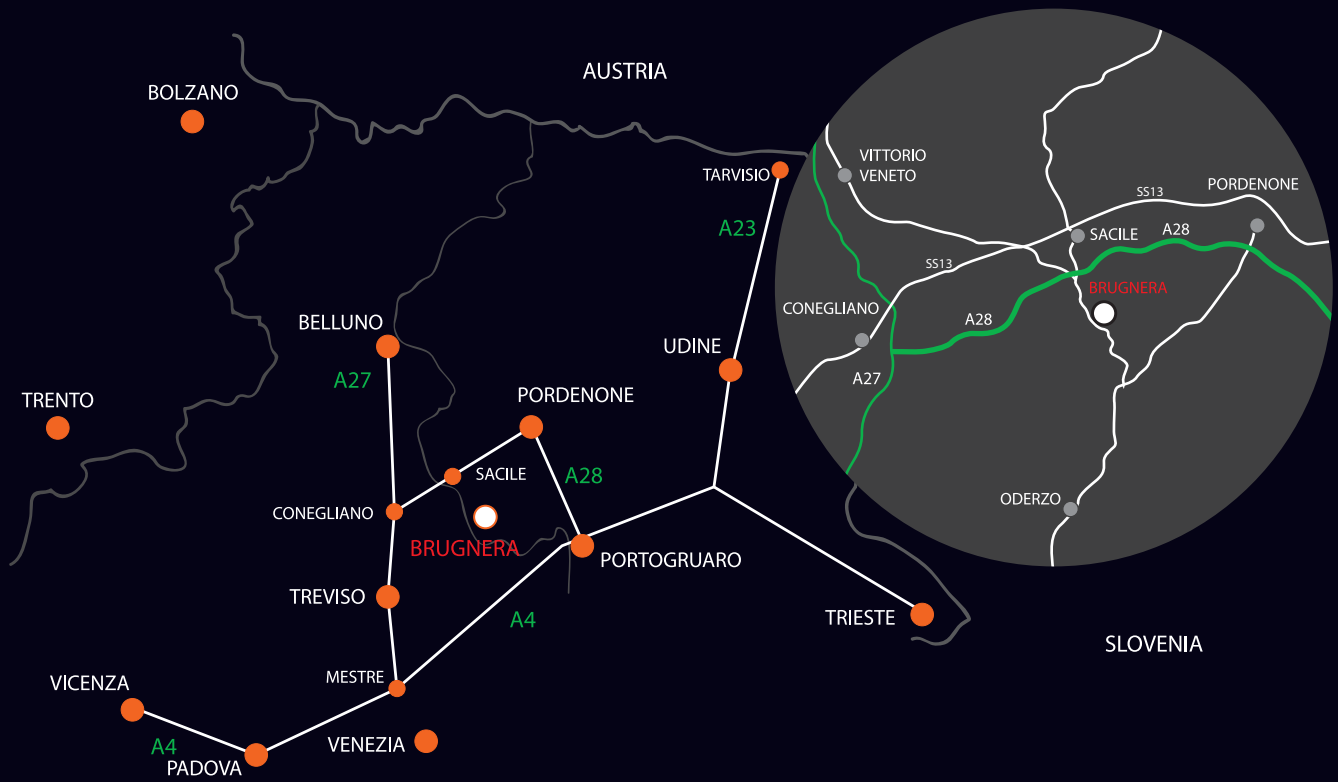

www.italianaferramenta.com